



SMD-CODE

DATABOOK

SMD-CODES

ACTIVE ELECTRONICS COMPONENTS

MARKING CODES
MARKING STYLE
CHARACTERISTICS
PINOUT



- 75.800 SMD codes for diodes, transistors, thyristors, integrated circuits
- Cases drawings and pinouts
- Connection diagrams

Edition 2008



ELECTRONICS

COMPONENTS

Active SMD components marking codes databook

Introduction

SMD-codes for semiconductor components in 2-pins cases

SMD-codes for semiconductor components in 3-pins cases

SMD-codes for semiconductor components in SOT-89 cases

SMD-codes for semiconductor components in SOT-223 cases

SMD-codes for semiconductor components in BGA and LPP cases

SMD-codes for semiconductor components in 4-pins cases

SMD-codes for semiconductor components in 5-pins cases

SMD-codes for semiconductor components in 6 and more pins cases

Conventional cases drawings. Cases pin assignments. Pinouts

SMD-codes marking style

Sample schematics diagrams

Logos, contact and web-adresses of the manufacturers

2 - pins

3 - pins

SOT - 89

SOT - 223

BGA...LPP

4 - pins

5 - pins

6... - pins

Introduction

Surface mount devices (SMDs) are used in a growing number of commercial and industrial products. SMDs have improved performance over through-hole components due to their smaller size, shorter internal leads, and smaller board layouts. These factors reduce the circuit's parasitic inductance and capacitance. SMDs can also be more cost effective than traditional through-hole components due to the smaller board size, fewer board layers, and fewer holes. Today more than 50% of active semiconductor components are surface-mounted.

At the same time, SMD devices are, by their very nature, too small to carry conventional semiconductor type numbers. Therefore, a somewhat arbitrary coding system has grown up, where the device package carries a simple one, two or more character or graphic ID code. Thus it is necessary to take into account that the colour and (or) placing of alphanumeric or graphic symbols are also important.

Identifying the manufacturers type number of an SMD device from the package code can be a difficult task. Unfortunately, each device code is not necessarily unique.

It is possible for various manufacturers to place different devices in the same case with the same SMD-code. For example, with a **6H** SMD-code in a SOT-23 case might be either a npn-transistor **BC818** (CDIL) or a capacitance-diode **FMMV2104** (Zetex) or a n-channel JFET transistor **MMBF5486** (Motorla) or a pnp-digital transistor **MUN2131** (Motorola) or a pnp-digital transistor **UN2117** (**Matsushita**) or a CMOS-integrated circuit- voltage detector with reset output **R3131N36EA** (Ricoh). Even the same manufacturer may use the same code for different devices.

To identify a particular SMD device, is necessary to identify the manufacturer, package style and note the ID code printed on the device.

The identification of the manufacturer is possible only if on the case are printed the manufacturer's logos, but it not always happens. Besides, sometimes it is possible to determine the manufacturer with indirect tags. Many recent Motorola devices have a small superscript letter after the device code, such as **SA^c** (this smaller letter is merely a month of manufacture code). Siemens and Infineon devices usually have a lower case '**s**' (ATs, LOs). Philips devices usually have a lower case '**p**' (Ahp, Z1p, pB0) or '**l**' (D-Q, Z-S) for the devices made in Hong Kong and '**t**' (ZtS, tT9, Y7t) for the devices made in Malaysia. In section 5 are submitted the logos of the SMD devices manufacturers.

The package style is another problem for the identification of SMD devices. The different manufacturers can designate identical cases according to the various standards (or according to the internal firm system). Besides the various cases can have an identical kind (form) and differ only by sizes, but this distinction of sizes so it is not enough, that can be measured only by special measuring devices. The conformity of the cases name of different manufacturers is submitted in the bottom table:

Table 1

JEDEC	EIAJ	Central Maxim Philips Siemens	Rohm	Sanyo	Hitachi	Motorola	KEC Toshiba	Panasonic
TO-236	SC-59	SOT-346	SMT3		MPAK2	SC-59	S-Mini	Mini3
TO-236AB		SOT-23	SST3	CP		SOT-23		
TO-243AA	SC-62	SOT-89A	MPT3		UPAK		PW-Mini	
TO-243AB	SC-62	SOT-89B						
TO252-3	SC-63		CPT3					
TO-253		SOT-143	SMT4			SOT-143		
TO-253	SC-61B	SOT-143R						
		SOD-123				SOD-123		
	SC-76	SOD-323	UMD2				USC	
		SOT-343						
		SOT-343R			CMPAK4			
	SC-70	SOT-323	UMT3	MCP	CMPAK	SOT-323	USM	
	SC-74		SMT6				SM6	
	SC-74A	SOT-753	SMT5				SMV	Mini5
	SC-75A	SOT-416	EMT3		SMPAK	SC-90	SSM	
	SC-79	SOT-523	EMD2	SSFP			S-Flat	SMini3
	SC-82		UMT4					
	SC-88	SOT-363	UMT6				US6	
	SC-88A	SOT-353	UMT5			SC70-5	USV	
	SC-89	SOT-490						
		SOT23-5				SC59-5		
	SC-73	SOT-223						
DO-214AC		SOD-106	PMDS					
DO-214AC		SOD-124						
	SC-81							SSMini3

In the following tables sections the SMD semiconductor components - irrelevant as to whether it is dealing with transistors, diodes, integrated circuits etc. are placed in separate tables according to numbers of terminals and (or) type of cases and are listed in strict alpha-numeric order by SMD-codes.

Column 1 (“SMD-Code”)

...(blue) Color of SMD code
 ...+ blue Color of cathode band

Column 2 (“Type”)

The type designations correspond to those of the respective manufacturer documentations.

Column 3 (“Device”)

Short definition of the semiconductor component.

Used abbreviations:

C-Diode	Capacitance diode (varactor, varicap)
CMOS-IC	CMOS integrated circuit
CMOS-Logic	CMOS logic integrated circuit
Comp-IC	Voltage comparator integrated circuit
CPE	Circuit protector element
Digi-IC	Digital integrated circuit
GaAs-Diode	Gallium-Arsenide diode
GaAs-N-FET	Gallium-Arsenide n-channel FET transistor
H-C	Hall effect integrated circuit
Lin/Dig-IC	Linear/digital combination integrated circuit
Lin-IC	Linear integrated circuit
MOS-...*	With integrated gate protection diode
MOS-FET-d	Metal oxide FET, depletion type
MOS-FET-e	Metal oxide FET, enhancement type
n-FET	n-channel field-effect transistor
n/p-FET	n and p-channel field-effect transistors
p-FET	p-channel field-effect transistor
Op-IC	Operational amplifier integrated circuit
SA-Diode	Surge absorption diode
Si-Diode	Silicon diode
Si-npn	Silicon npn transistor
Si-npn-Darl	Silicon npn Darlington transistor
Si-npn-Digi	Silicon npn “digital” transistor
SiGe-npn	Silicon/Germanium npn transistor
Si-pnp	Silicon pnp transistor
Si-pnp-Darl	Silicon pnp Darlington transistor
Si-pnp-Digi	Silicon pnp “digital” transistor
Si-Stab	Silicon stabilistor
Therm-S	Thermal sensor Integrated Circuit
Thy-SPD	Thyristor-surge protector device
TTL-Logic	Transistor-Transistor Logic integrated circuit
TVS	Transient voltage suppressor
VR-IC	Voltage regulator integrated circuit
Vref-IC	Voltage reference integrated circuit
Z-Diode	Zener diode
Z-Diode/TVS	Zener diode - transient voltage suppressor

Column 4 (“Short description”)

Short data or description of function of each type.

Used abbreviations:

Adj.	Adjust, adjustable
AF	Audio Frequency
AGC	Automatic Gain Control
ALC	Automatic Level Control
AM	Amplitude Modulation (AM range)
Amp	Amplifier
Ant	Antenna
Att	Attenuator
Aval	Avalanche
BTL	Bridge Tied Loads
Buff	Buffer
CATV	Broad band cable amplifier
Cell	Cellular
Contr	Controlled
Conv	Converter
Cordl	Cordless
Det	Detector
Diff	Differential
Dr, Drv	Driver

Ext.	External
FM	Frequency Modulation (FM range)
GaAs	Gallium arsenide
GP	General Purpose Applications
HF	High Frequency
Hi-sp	High-speed
HV	High Voltage
Instrum.	Instrumental
Latch-Pr.	Latch-Protection
LDO	Low drop voltage
LED	Light-emitting diode
LLS	Logic Level Shifter
LN	Low Noise
LogL	Logic Level (Uth > 0,8...2V)
Lo-sat	Low collector-emitter saturation voltage
Mix	Mixer
MR	Manual Reset
ODO	Open Drain Output
OVP	Over Voltage protection
Osc	Oscillator
Out	Output
PA	Power Amplifier
Pow	Power
PPO	Push-Pull Output
PWM	Pulse-width modulation
Rect	Rectifier
Reg	Regulated
Res.	Resistor
Reset-Pr.	Reset-Protection
RF	Radio Frequency applications
St-Down	Step-Down
Supress.	Suppressor
Sw.	Switching
T-MOS	Trench-FET MOSFET
Tun	Tuner
U-Speed	Ultra-speed
UHF	RF applications (>250 MHz)
Var	Variable
VCO	Voltage controlled oscillator
VDet	Voltage Detector
VHF	RF applications (100...250MHz)
Vid	Video output stages
V-MOS	
VR	Voltage Regulator
WB	Wide Band

Column 5 (“Case”)

Manufacturers cases designation.

Column 6 (“Pin.”)

Related drawing number (figure) and pin assignment (section 2). All drawings are situated also in the section 2.

Column 7 (“Sch.”)

Sample schematic connection for some ICs. All drawings are situated in the section 4.

Column 8 (“St.”)

“Style” (uppercase placement presentation) of the SMD-code drawing. All drawings are situated in the section 3.

Column 9 (“Mnf.”)

The names of the manufacturers are abbreviated to save space. The complete name, logos, contact and web-addresses of each manufacturer is listed alphabetically on section 5.

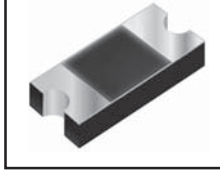
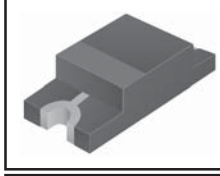
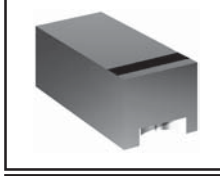
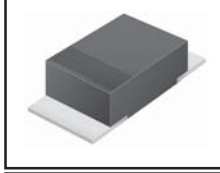
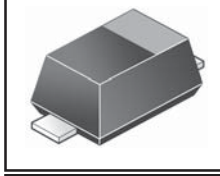
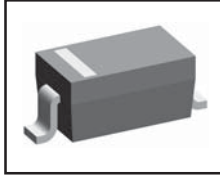
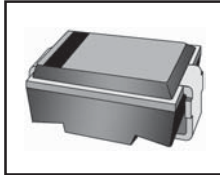

2-pins SMD semiconductor components
SMD-codes for 2-pins cases semiconductor components

SMD code	Type	Function	Short description	Case	Pin.	St.	Mnf.
<Z	TCMM3Z75VB	Z-diode	75V±2%, Izt=5mA, Zzt=240Ω, 200mW	SOD-323F	6d	1a	Tac
=Z	TCMM3Z56VB	Z-diode	56V±2%, Izt=5mA, Zzt=188Ω, 200mW	SOD-323F	6d	1a	Tac
>Z	TCMM3Z68VB	Z-diode	68V±2%, Izt=5mA, Zzt=226Ω, 200mW	SOD-323F	6d	1a	Tac
0	HVC300A	C-diode	VHF-Tuning, 32V, 2.6..39.5pF(25V..2V/1MHz)	UFP	6d	1b	Hit
0	HVE300A	C-diode	VHF-Tuning, 39.5..47.4pF(2V)	SOD-123	5d	1a	Hit
0	HVU300A	C-diode	VHF-Tuning, 32V, 2.6..39.5pF(25..2V, 1MHz)	SOD-323	5d	1a	Ren
0 2	GDZ2V0B-V	Z-diode	2.02..2.2V, Izt=5mA, Zzt=100Ω, 200mW	SOD-323	5d	1k	Vs
00	MM3Z2V4	Z-diode	2.2..2.6V, 5mA, Zzt=100Ω, 200mW	SOD-323	5d	1a	Ons,Sec
00	MM5Z2V4	Z-diode	2.2..2.6V, 5mA, Zzt=100Ω, 100mW	SOD-523	6d	1a	Ons,Wtr
00	ZD02V4	Z-diode	2.2..2.6V, 5mA, Zzt=100Ω, 200mW	SOD-322	5d	1a	Ctc
01	MM3Z2V7(T1)	Z-diode	2.5..2.9V, 5mA, Zzt=100Ω, 200mW	SOD-323	5d	1a	Sec
01	MM5Z2V7(T1)	Z-diode	2.5..2.9V, 5mA, Zzt=100Ω, 100mW	SOD-523	6d	1a	Wtr
01	ZD02V7	Z-diode	2.5..2.9V, 5mA, Zzt=100Ω, 200mW	SOD-322	5d	1a	Ctc
01C100PH	BZG01-C100	Z-diode	100V±5%, 1.5W	DO-214AC	1d	1a	Phi
01C10PH	BZG01-C10	Z-diode	10V±5%, 1.5W	DO-214AC	1d	1a	Phi
01C110PH	BZG01-C110	Z-diode	110V±5%, 1.5W	DO-214AC	1d	1a	Phi
01C11PH	BZG01-C11	Z-diode	11V±5%, 1.5W	DO-214AC	1d	1a	Phi
01C120PH	BZG01-C120	Z-diode	120V±5%, 1.5W	DO-214AC	1d	1a	Phi
01C12PH	BZG01-C12	Z-diode	12V±5%, 1.5W	DO-214AC	1d	1a	Phi
01C130PH	BZG01-C130	Z-diode	130V±5%, 1.5W	DO-214AC	1d	1a	Phi
01C13PH	BZG01-C13	Z-diode	13V±5%, 1.5W	DO-214AC	1d	1a	Phi
01C150PH	BZG01-C150	Z-diode	150V±5%, 1.5W	DO-214AC	1d	1a	Phi
01C15PH	BZG01-C15	Z-diode	15V±5%, 1.5W	DO-214AC	1d	1a	Phi
01C160PH	BZG01-C160	Z-diode	160V±5%, 1.5W	DO-214AC	1d	1a	Phi
01C16PH	BZG01-C16	Z-diode	16V±5%, 1.5W	DO-214AC	1d	1a	Phi
01C180PH	BZG01-C180	Z-diode	180V±5%, 1.5W	DO-214AC	1d	1a	Phi
01C18PH	BZG01-C18	Z-diode	18V±5%, 1.5W	DO-214AC	1d	1a	Phi
01C200PH	BZG01-C200	Z-diode	200V±5%, 1.5W	DO-214AC	1d	1a	Phi
01C20PH	BZG01-C20	Z-diode	20V±5%, 1.5W	DO-214AC	1d	1a	Phi
01C220PH	BZG01-C220	Z-diode	220V±5%, 1.5W	DO-214AC	1d	1a	Phi
01C22PH	BZG01-C22	Z-diode	22V±5%, 1.5W	DO-214AC	1d	1a	Phi
01C240PH	BZG01-C240	Z-diode	270V±5%, 1.5W	DO-214AC	1d	1a	Phi
01C24PH	BZG01-C24	Z-diode	24V±5%, 1.5W	DO-214AC	1d	1a	Phi
01C270PH	BZG01-C270	Z-diode	270V±5%, 1.5W	DO-214AC	1d	1a	Phi
01C27PH	BZG01-C27	Z-diode	27V±5%, 1.5W	DO-214AC	1d	1a	Phi
01C30PH	BZG01-C30	Z-diode	30V±5%, 1.5W	DO-214AC	1d	1a	Phi
01C33PH	BZG01-C33	Z-diode	33V±5%, 1.5W	DO-214AC	1d	1a	Phi
01C36PH	BZG01-C36	Z-diode	36V±5%, 1.5W	DO-214AC	1d	1a	Phi
01C39PH	BZG01-C39	Z-diode	39V±5%, 1.5W	DO-214AC	1d	1a	Phi
01C43PH	BZG01-C43	Z-diode	43V±5%, 1.5W	DO-214AC	1d	1a	Phi
01C47PH	BZG01-C47	Z-diode	47V±5%, 1.5W	DO-214AC	1d	1a	Phi
01C51PH	BZG01-C51	Z-diode	51V±5%, 1.5W	DO-214AC	1d	1a	Phi
01C56PH	BZG01-C56	Z-diode	56V±5%, 1.5W	DO-214AC	1d	1a	Phi
01C62PH	BZG01-C62	Z-diode	62V±5%, 1.5W	DO-214AC	1d	1a	Phi
01C68PH	BZG01-C68	Z-diode	68V±5%, 1.5W	DO-214AC	1d	1a	Phi
01C75PH	BZG01-C75	Z-diode	75V±5%, 1.5W	DO-214AC	1d	1a	Phi
01C82PH	BZG01-C82	Z-diode	82V±5%, 1.5W	DO-214AC	1d	1a	Phi
01C91PH	BZG01-C91	Z-diode	91V±5%, 1.5W	DO-214AC	1d	1a	Phi
02	MM3Z3V0	Z-diode	2.8..3.2V, 5mA, Zzt=95Ω, 200mW	SOD-323	5d	1a,1d	Ons,Sec
02	MM5Z3V0	Z-diode	2.8..3.2V, 5mA, Zzt=100Ω, 100mW	SOD-523	6d	1a,1u	Ons,Wtr
02	ZD03V0	Z-diode	2.8..3.2V, 5mA, Zzt=100Ω, 200mW	SOD-322	5d	1a	Ctc
03C 10	BZG03-C10	Z-diode	10V±5%, Izt=50mA, Zzt=2Ω, 1.25W	DO-214AC	1d	1a	Sil
03C 100	BZG03-C100	Z-diode	100V±5%, Izt=5mA, Zzt=60Ω, 1.25W	DO-214AC	1d	1a	Sil
03C 100PH	BZG03-C100	Z-diode	100V±5%, Izt=5mA, Zzt=60Ω, 1.25W	DO-214AC	1d	1a	Phi
03C 10PH	BZG03-C10	Z-diode	10V±5%, Izt=50mA, Zzt=2Ω, 1.25W	DO-214AC	1d	1a	Phi
03C 11	BZG03-C11	Z-diode	11V±5%, Izt=50mA, Zzt=4Ω, 1.25W	DO-214AC	1d	1a	Sil
03C 110	BZG03-C110	Z-diode	110V±5%, Izt=5mA, Zzt=80Ω, 1.25W	DO-214AC	1d	1a	Sil
03C 110PH	BZG03-C110	Z-diode	110V±5%, Izt=5mA, Zzt=80Ω, 1.25W	DO-214AC	1d	1a	Phi
03C 11PH	BZG03-C11	Z-diode	11V±5%, Izt=50mA, Zzt=4Ω, 1.25W	DO-214AC	1d	1a	Phi
03C 12	BZG03-C12	Z-diode	12V±5%, Izt=50mA, Zzt=4Ω, 1.25W	DO-214AC	1d	1a	Sil
03C 120	BZG03-C120	Z-diode	120V±5%, Izt=5mA, Zzt=80Ω, 1.25W	DO-214AC	1d	1a	Sil
03C 120PH	BZG03-C120	Z-diode	120V±5%, Izt=5mA, Zzt=80Ω, 1.25W	DO-214AC	1d	1a	Phi
03C 12PH	BZG03-C12	Z-diode	12V±5%, Izt=50mA, Zzt=4Ω, 1.25W	DO-214AC	1d	1a	Phi
03C 13	BZG03-C13	Z-diode	13V±5%, Izt=50mA, Zzt=5Ω, 1.25W	DO-214AC	1d	1a	Sil
03C 130	BZG03-C130	Z-diode	130V±5%, Izt=5mA, Zzt=110Ω, 1.25W	DO-214AC	1d	1a	Sil
03C 130PH	BZG03-C130	Z-diode	130V±5%, Izt=5mA, Zzt=110Ω, 1.25W	DO-214AC	1d	1a	Phi
03C 13PH	BZG03-C13	Z-diode	13V±5%, Izt=50mA, Zzt=5Ω, 1.25W	DO-214AC	1d	1a	Phi
03C 15	BZG03-C15	Z-diode	15V±5%, Izt=50mA, Zzt=5Ω, 1.25W	DO-214AC	1d	1a	Sil
03C 150	BZG03-C150	Z-diode	150V±5%, Izt=5mA, Zzt=130Ω, 1.25W	DO-214AC	1d	1a	Sil
03C 150PH	BZG03-C150	Z-diode	150V±5%, Izt=5mA, Zzt=130Ω, 1.25W	DO-214AC	1d	1a	Phi
03C 15PH	BZG03-C15	Z-diode	15V±5%, Izt=50mA, Zzt=5Ω, 1.25W	DO-214AC	1d	1a	Phi
03C 16	BZG03-C16	Z-diode	16V±5%, Izt=25mA, Zzt=6Ω, 1.25W	DO-214AC	1d	1a	Sil
03C 160	BZG03-C160	Z-diode	160V±5%, Izt=5mA, Zzt=150Ω, 1.25W	DO-214AC	1d	1a	Sil
03C 160PH	BZG03-C160	Z-diode	160V±5%, Izt=5mA, Zzt=150Ω, 1.25W	DO-214AC	1d	1a	Phi
03C 16PH	BZG03-C16	Z-diode	16V±5%, Izt=25mA, Zzt=6Ω, 1.25W	DO-214AC	1d	1a	Phi

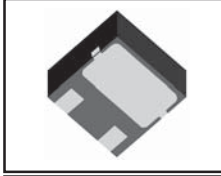
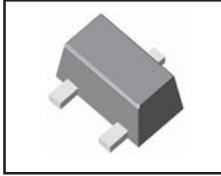
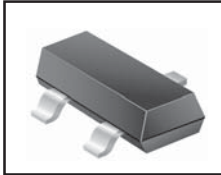

3-pins SMD semiconductor components
SMD-codes for 3-pins cases semiconductor components

3 - pins

SMD code	Type	Function	Short description	Case	Pin. St.	Sch.	Mnf.
+P2	BFR92A	Si-npn	UHF-A-Band, 20V, 25mA, 300mW, B>40, >5GHz	SOT-23	16ta 3a	-	Sil
+P5	BFR92AR	Si-npn	UHF-A-Band, 20V, 25mA, 300mW, B>40, >5GHz	SOT-23	16te 3a	-	Sil
+R2	BFR93A	Si-npn	UHF-A-Band, 15V, 30mA, 300mW, B>40, >5GHz	SOT-23	16ta 3a	-	Sil
+R5	BFR93AR	Si-npn	UHF-A-Band, 15V, 30mA, 300mW, B>40, >5GHz	SOT-23	16te 3a	-	Sil
01	PDTA143EE	Si-npn-Digi	Sw, 50V, 100mA, 150mW, R1/R2=4.7k/4.7k	SC-75	16ta 3a	-	Phi
01	PDTA143EK	Si-npn-Digi	Sw, 50V, 100mA, 250mW, R1/R2=4.7k/4.7k	SC-59	16ta 3a	-	Phi
011	SO2369R	Si-npn	Sw, 40V, 200mA, 330mW, B=40..120	SOT-23R	16te 3a	-	Ste
01A	APR3001-15A	CMOS-IC	Voltage detector, 1.5V, -Reset Push-pull output	SOT-23	16vdb 3b	VD7	Anp
01B	APR3001-17A	CMOS-IC	Voltage detector, 1.75V, -Reset Push-pull output	SOT-23	16vdb 3b	VD7	Anp
01C	APR3001-23A	CMOS-IC	Voltage detector, 2.32V, -Reset Push-pull output	SOT-23	16vdb 3b	VD7	Anp
01D	APR3001-26A	CMOS-IC	Voltage detector, 2.63V, -Reset Push-pull output	SOT-23	16vdb 3b	VD7	Anp
01E	APR3001-29A	CMOS-IC	Voltage detector, 2.93V, -Reset Push-pull output	SOT-23	16vdb 3b	VD7	Anp
01F	APR3001-30A	CMOS-IC	Voltage detector, 3.08V, -Reset Push-pull output	SOT-23	16vdb 3b	VD7	Anp
01G	APR3001-39A	CMOS-IC	Voltage detector, 3.9V, -Reset Push-pull output	SOT-23	16vdb 3b	VD7	Anp
01H	APR3001-43A	CMOS-IC	Voltage detector, 4.38V, -Reset Push-pull output	SOT-23	16vdb 3b	VD7	Anp
01J	APR3001-46A	CMOS-IC	Voltage detector, 4.63V, -Reset Push-pull output	SOT-23	16vdb 3b	VD7	Anp
02	BSX39	Si-npn	Sw, Driver, 45V, 0.2A, <12/18ns	SOT-23	16te 3a	-	Mot
02	PDTC143EE	Si-npn-Digi	Sw, 50V, 100mA, 150mW, R1/R2=4.7k/4.7k	SC-75	16ta 3a	-	Phi
02	PDTC143EK	Si-npn-Digi	Sw, 50V, 100mA, 150mW, R1/R2=4.7k/4.7k	SC-59	16ta 3a	-	Phi
02A	APR3002-15A	CMOS-IC	Voltage detector, 1.5V, Reset Push-pull output	SOT-23	16vdb 3b	VD7	Anp
02C	APR3002-23A	CMOS-IC	Voltage detector, 2.32V, Reset Push-pull output	SOT-23	16vdb 3b	VD7	Anp
02D	APR3002-26A	CMOS-IC	Voltage detector, 2.63V, Reset Push-pull output	SOT-23	16vdb 3b	VD7	Anp
02E	APR3002-29A	CMOS-IC	Voltage detector, 2.93V, Reset Push-pull output	SOT-23	16vdb 3b	VD7	Anp
02F	APR3002-30A	CMOS-IC	Voltage detector, 3.08V, Reset Push-pull output	SOT-23	16vdb 3b	VD7	Anp
02G	APR3002-39A	CMOS-IC	Voltage detector, 3.9V, Reset Push-pull output	SOT-23	16vdb 3b	VD7	Anp
02H	APR3002-43A	CMOS-IC	Voltage detector, 4.38V, Reset Push-pull output	SOT-23	16vdb 3b	VD7	Anp
02J	APR3002-46A	CMOS-IC	Voltage detector, 4.63V, Reset Push-pull output	SOT-23	16vdb 3b	VD7	Anp
03	DTC143TE	Si-npn-Digi	Sw, 50V, 100mA, 150mW, 250MHz, R1=4k7	SOT-416	16ta 3a	-	Rhm
03	DTC143TKA	Si-npn-Digi	Sw, 50V, 100mA, 200mW, 250MHz, R1=4k7	SOT-346	16ta 3a	-	Rhm
03	DTC143TM	Si-npn-Digi	Sw, 50V, 100mA, 150mW, 250MHz, R1=4k7	VMT3	18ta 3a	-	Rhm
03	DTC143TUA	Si-npn-Digi	Sw, 50V, 100mA, 200mW, 250MHz, R1=4.7k	UMT3	16ta 3a	-	Rhm
03	MSCT03	TVS	3.3V, 300W (8/20µs)	SOT-23	16dh 3a	-	Msp
03	PDTA114EE	Si-npn-Digi	Sw, 50V, 100mA, 150mW, R1/R2=10k/10k	SC-75	16ta 3a	-	Phi
03	PDTA114EEF	Si-npn-Digi	Sw, 50V, 100mA, 250mW, R1/R2=10k/10k	SOT-490	18ta 3a	-	Phi
03	PDTA114EK	Si-npn-Digi	Sw, 50V, 100mA, 250mW, R1/R2=10k/10k	SC-59	16ta 3a	-	Phi
-03	PDTA114EU	Si-npn-Digi	Sw, 50V, 100mA, 200mW, R1/R2=10k/10k	SOT-323	16ta 3a	-	PhH
03A	APR3003-15A	CMOS-IC	Voltage detector, 1.5V, -Reset Open drain output	SOT-23	16vdb 3b	VD6	Anp
03B	APR3003-17A	CMOS-IC	Voltage detector, 1.75V, -Reset Open drain output	SOT-23	16vdb 3b	VD6	Anp
03C	APR3003-23A	CMOS-IC	Voltage detector, 2.32V, -Reset Open drain output	SOT-23	16vdb 3b	VD6	Anp
03C	MSCT03C	TVS	3.3V, 300W (8/20µs), Bidirectional	SOT-23	16dp 3a	-	Msp
03D	APR3003-26A	CMOS-IC	Voltage detector, 2.63V, -Reset Open drain output	SOT-23	16vdb 3b	VD6	Anp
03E	APR3003-29A	CMOS-IC	Voltage detector, 2.93V, -Reset Open drain output	SOT-23	16vdb 3b	VD6	Anp
03F	APR3003-30A	CMOS-IC	Voltage detector, 3.08V, -Reset Open drain output	SOT-23	16vdb 3b	VD6	Anp
03G	APR3003-39A	CMOS-IC	Voltage detector, 3.9V, -Reset Open drain output	SOT-23	16vdb 3b	VD6	Anp
03H	APR3003-43A	CMOS-IC	Voltage detector, 4.38V, -Reset Open drain output	SOT-23	16vdb 3b	VD6	Anp
03J	APR3003-46A	CMOS-IC	Voltage detector, 4.63V, -Reset Open drain output	SOT-23	16vdb 3b	VD6	Anp
04	PDTC114EK	Si-npn-Digi	Sw, 50V, 100mA, 250mW, R1/R2=10k/10k	SC-59	16ta 3a	-	Phi
-04	PMS33904	Si-npn	GP, 60V, 100mA, 200mW, B=100..300, >180MHz	SC-70	16ta 3a	-	PhH
05	DTC124TE	Si-npn-Digi	Sw, 50V, 100mA, 150mW, 250MHz, R1=22k	SOT-416	16ta 3a	-	Rhm
05	DTC124TKA	Si-npn-Digi	Sw, 50V, 100mA, 200mW, 250MHz, R1=22k	SOT-346	16ta 3a	-	Rhm
05	DTC124TM	Si-npn-Digi	Sw, 50V, 100mA, 150mW, 250MHz, R1=22k	VMT3	18ta 3a	-	Rhm
05	DTC124TUA	Si-npn-Digi	Sw, 50V, 100mA, 200mW, B=111..600, >200MHz, R1=22k	UMT3	16ta 3a	-	Rhm
05	MSCT05	TVS	5V, 300W (8/20µs)	SOT-23	16dh 3a	-	Msp
05	PDTA124EE	Si-npn-Digi	Sw, 50V, 100mA, 150mW, R1/R2=22k/22k	SC-75	16ta 3a	-	Phi
05	PDTA124EK	Si-npn-Digi	Sw, 50V, 100mA, 250mW, R1/R2=22k/22k	SC-59	16ta 3a	-	Phi
05C	MSCT05C	TVS	5V, 300W (8/20µs), Bidirectional	SOT-23	16dp 3a	-	Msp
06	PDTC124EE	Si-npn-Digi	Sw, 50V, 100mA, 150mW, R1/R2=22k/22k	SC-75	16ta 3a	-	Phi
06	PDTC124EK	Si-npn-Digi	Sw, 50V, 100mA, 250mW, R1/R2=22k/22k	SC-59	16ta 3a	-	Phi
-06	PMS33906	Si-npn	GP, 60V, 100mA, 200mW, B=100..300, >150MHz	SC-70	16ta 3a	-	PhH
07	PDTA144EE	Si-npn-Digi	Sw, 50V, 100mA, 150mW, R1/R2=47k/47k	SC-75	16ta 3a	-	Phi
07	PDTA144EEF	Si-npn-Digi	Sw, 50V, 100mA, 250mW, R1/R2=47k/47k	SOT-490	18ta 3a	-	Phi
07	PDTA144EK	Si-npn-Digi	Sw, 50V, 100mA, 250mW, R1/R2=47k/47k	SC-59	16ta 3a	-	Phi
08	MSCT08	TVS	8V, 300W (8/20µs)	SOT-23	16dh 3a	-	Msp
08	PDTC144EE	Si-npn-Digi	Sw, 50V, 100mA, 150mW, R1/R2=47k/47k	SC-75	16ta 3a	-	Phi
08	PDTC144EEF	Si-npn-Digi	Sw, 50V, 100mA, 250mW, R1/R2=47k/47k	SOT-490	18ta 3a	-	Phi
08	PDTC144EK	Si-npn-Digi	Sw, 50V, 100mA, 250mW, R1/R2=47k/47k	SC-59	16ta 3a	-	Phi
081	SO2369AR	Si-npn	Sw, 40V, 200mA, 330mW, B=40..120	SOT-23R	16te 3a	-	Ste
08C	MSCT08C	TVS	8V, 300W (8/20µs), Bidirectional	SOT-23	16dp 3a	-	Msp
09	DTC115TE	Si-npn-Digi	Sw, 50V, 100mA, 150mW, 250MHz, R1=100k	SOT-416	16ta 3a	-	Rhm
09	DTC115TKA	Si-npn-Digi	Sw, 50V, 100mA, 200mW, 250MHz, R1=100k	SOT-346	16ta 3a	-	Rhm
09	DTC115TM	Si-npn-Digi	Sw, 50V, 100mA, 150mW, 250MHz, R1=100k	VMT3	18ta 3a	-	Rhm
09	DTC115TUA	Si-npn-Digi	Sw, 50V, 100mA, 200mW, 250MHz, R1=100k	UMT3	16ta 3a	-	Rhm
09	PDTC114EE	Si-npn-Digi	Sw, 50V, 100mA, 150mW, R1/R2=10k/10k	SC-75	16ta 3a	-	Phi
09	PDTC114EEF	Si-npn-Digi	Sw, 50V, 100mA, 250mW, R1/R2=10k/10k	SOT-490	18ta 3a	-	Phi
-09	PDTC114EU	Si-npn-Digi	Sw, 50V, 100mA, 200mW, R1/R2=10k/10k	SOT-323	16ta 3a	-	PhH

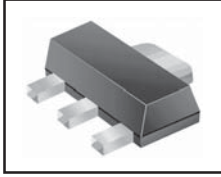

SMD semiconductor components in SOT-89 cases
SMD-codes for semiconductor components in SOT-89 cases

SMD code	Type	Function	Short description	Case	Pin.	St.	Sch.	Mnf.
01	Gali-1	Lin-IC	RF amplifier, DC..8GHz, 11dB (50Ω)	SOT-89	20aa	4b	A1	Mc
01A	APR3001-15D	CMOS-IC	Voltage detector, 1.5V, -Reset Push-pull output	SOT-89	20vda	4b	VD7	Anp
01B	APR3001-17D	CMOS-IC	Voltage detector, 1.75V, -Reset Push-pull output	SOT-89	20vda	4b	VD7	Anp
01C	APR3001-23D	CMOS-IC	Voltage detector, 2.32V, -Reset Push-pull output	SOT-89	20vda	4b	VD7	Anp
01D	APR3001-26D	CMOS-IC	Voltage detector, 2.63V, -Reset Push-pull output	SOT-89	20vda	4b	VD7	Anp
01E	APR3001-29D	CMOS-IC	Voltage detector, 2.93V, -Reset Push-pull output	SOT-89	20vda	4b	VD7	Anp
01F	APR3001-30D	CMOS-IC	Voltage detector, 3.08V, -Reset Push-pull output	SOT-89	20vda	4b	VD7	Anp
01G	APR3001-39D	CMOS-IC	Voltage detector, 3.9V, -Reset Push-pull output	SOT-89	20vda	4b	VD7	Anp
01H	APR3001-43D	CMOS-IC	Voltage detector, 4.38V, -Reset Push-pull output	SOT-89	20vda	4b	VD7	Anp
01J	APR3001-46D	CMOS-IC	Voltage detector, 4.63V, -Reset Push-pull output	SOT-89	20vda	4b	VD7	Anp
02	Gali-2	Lin-IC	RF amplifier, DC..8GHz, 15,1dB (50Ω)	SOT-89	20aa	4b	A1	Mc
02A	APR3002-15D	CMOS-IC	Voltage detector, 1.5V, Reset Push-pull output	SOT-89	20vda	4b	VD7	Anp
02B	APR3002-17D	CMOS-IC	Voltage detector, 1.75V, Reset Push-pull output	SOT-89	20vda	4b	VD7	Anp
02C	APR3002-23D	CMOS-IC	Voltage detector, 2.32V, Reset Push-pull output	SOT-89	20vda	4b	VD7	Anp
02D	APR3002-26D	CMOS-IC	Voltage detector, 2.63V, Reset Push-pull output	SOT-89	20vda	4b	VD7	Anp
02E	APR3002-29D	CMOS-IC	Voltage detector, 2.93V, Reset Push-pull output	SOT-89	20vda	4b	VD7	Anp
02F	APR3002-30D	CMOS-IC	Voltage detector, 3.08V, Reset Push-pull output	SOT-89	20vda	4b	VD7	Anp
02G	APR3002-39D	CMOS-IC	Voltage detector, 3.9V, Reset Push-pull output	SOT-89	20vda	4b	VD7	Anp
02H	APR3002-43D	CMOS-IC	Voltage detector, 4.38V, Reset Push-pull output	SOT-89	20vda	4b	VD7	Anp
02J	APR3002-46D	CMOS-IC	Voltage detector, 4.63V, Reset Push-pull output	SOT-89	20vda	4b	VD7	Anp
03	Gali-3	Lin-IC	RF amplifier, DC..3GHz, 15,8dB (50Ω)	SOT-89	20aa	4b	A1	Mc
03A	APR3003-15D	CMOS-IC	Voltage detector, 1.5V, -Reset Open drain output	SOT-89	20vda	4b	VD6	Anp
03B	APR3003-17D	CMOS-IC	Voltage detector, 1.75V, -Reset Open drain output	SOT-89	20vda	4b	VD6	Anp
03C	APR3003-23D	CMOS-IC	Voltage detector, 2.32V, -Reset Open drain output	SOT-89	20vda	4b	VD6	Anp
03D	APR3003-26D	CMOS-IC	Voltage detector, 2.63V, -Reset Open drain output	SOT-89	20vda	4b	VD6	Anp
03E	APR3003-29D	CMOS-IC	Voltage detector, 2.93V, -Reset Open drain output	SOT-89	20vda	4b	VD6	Anp
03F	APR3003-30D	CMOS-IC	Voltage detector, 3.08V, -Reset Open drain output	SOT-89	20vda	4b	VD6	Anp
03G	APR3003-39D	CMOS-IC	Voltage detector, 3.9V, -Reset Open drain output	SOT-89	20vda	4b	VD6	Anp
03H	APR3003-43D	CMOS-IC	Voltage detector, 4.38V, -Reset Open drain output	SOT-89	20vda	4b	VD6	Anp
03J	APR3003-46D	CMOS-IC	Voltage detector, 4.63V, -Reset Open drain output	SOT-89	20vda	4b	VD6	Anp
04	Gali-4	Lin-IC	RF amplifier, DC..4GHz, 13,1dB (50Ω)	SOT-89	20aa	4b	A1	Mc
047	FCX1047A	Si-npn	Hi-beta, Lo-sat, 35V, 4A, 150MHz	SOT-89	20tb	4b	-	Zx
04F	Gali-4F	Lin-IC	RF amplifier, DC..4GHz, 13,2dB (50Ω)	SOT-89	20aa	4b	A1	Mc
05	Gali-5	Lin-IC	RF amplifier, DC..4GHz, 15,1dB (50Ω)	SOT-89	20aa	4b	A1	Mc
051	FCX1051A	Si-npn	Hi-beta, Lo-sat, 150V, 3A, 155MHz	SOT-89	20tb	4b	-	Zx
05F	Gali-5F	Lin-IC	RF amplifier, DC..4GHz, 15,1dB (50Ω)	SOT-89	20aa	4b	A1	Mc
06	Gali-6	Lin-IC	RF amplifier, DC..4GHz, 12,3dB (50Ω)	SOT-89	20aa	4b	A1	Mc
06F	Gali-6F	Lin-IC	RF amplifier, DC..4GHz, 12,3dB (50Ω)	SOT-89	20aa	4b	A1	Mc
0B	RH5RL20AA	VR-IC	2V±2,5%, 150mA	SOT-89	20vl	4c	VR1	Ric
0C	MC78LC30HT1	VR-IC	Low Iq, 3V±2,5%, 80mA	SOT-89	20vl		VR1	Ons
0C	RH5RL30AA	VR-IC	3V±2,5%, 150mA	SOT-89	20vl	4c	VR1	Ric
0D	RH5RL40AA	VR-IC	4V±2,5%, 150mA	SOT-89	20vl	4c	VR1	Ric
0E	RH5RL50AA	VR-IC	5V±2,5%, 150mA	SOT-89	20vl	4c	VR1	Ric
0F	RH5RL60AA	VR-IC	6V±2,5%, 150mA	SOT-89	20vl	4c	VR1	Ric
0J	RH5RE20AA	VR-IC	Ultra-LDO, 2V±2,5%, 300mA	SOT-89	20vl	4c	VR1	Ric
0K	RH5RE30AA	VR-IC	Ultra-LDO, 3V±2,5%, 300mA	SOT-89	20vl	4c	VR1	Ric
0L	RH5RE40AA	VR-IC	Ultra-LDO, 4V±2,5%, 300mA	SOT-89	20vl	4c	VR1	Ric
0M	RH5RE50AA	VR-IC	Ultra-LDO, 5V±2,5%, 300mA	SOT-89	20vl	4c	VR1	Ric
0N	RH5RE60AA	VR-IC	Ultra-LDO, 6V±2,5%, 300mA	SOT-89	20vl	4c	VR1	Ric
1019	EC1019B	Lin-IC	RF amplifier, DC..4GHz, 20dB (50Ω)	SOT-89	20aa	4b	A1	Wjc
1019G	EC1019B-G	Lin-IC	RF amplifier, DC..4GHz, 20dB (50Ω)	SOT-89	20aa	4b	A1	Wjc
10Y	BZV49-C10	Z-diode	10V±5%, Izt=5mA, 1W	SOT-89	20dm	4b	-	Phi
11A	APR3011-15D	CMOS-IC	Voltage detector, 1.5V, -Reset Push-pull output	SOT-89	20vde	4b	VD7	Anp
11B	APR3011-17D	CMOS-IC	Voltage detector, 1.75V, -Reset Push-pull output	SOT-89	20vde	4b	VD7	Anp
11C	APR3011-23D	CMOS-IC	Voltage detector, 2.32V, -Reset Push-pull output	SOT-89	20vde	4b	VD7	Anp
11D	APR3011-26D	CMOS-IC	Voltage detector, 2.63V, -Reset Push-pull output	SOT-89	20vde	4b	VD7	Anp
11E	APR3011-29D	CMOS-IC	Voltage detector, 2.93V, -Reset Push-pull output	SOT-89	20vde	4b	VD7	Anp
11F	APR3011-30D	CMOS-IC	Voltage detector, 3.08V, -Reset Push-pull output	SOT-89	20vde	4b	VD7	Anp
11G	APR3011-39D	CMOS-IC	Voltage detector, 3.9V, -Reset Push-pull output	SOT-89	20vde	4b	VD7	Anp
11H	APR3011-43D	CMOS-IC	Voltage detector, 4.38V, -Reset Push-pull output	SOT-89	20vde	4b	VD7	Anp
11J	APR3011-46D	CMOS-IC	Voltage detector, 4.63V, -Reset Push-pull output	SOT-89	20vde	4b	VD7	Anp
11Y	BZV49-C11	Z-diode	11V±5%, Izt=5mA, 1W	SOT-89	20dm	4b	-	Phi
12A	APR3012-15D	CMOS-IC	Voltage detector, 1.5V, Reset Push-pull output	SOT-89	20vde	4b	VD7	Anp
12B	APR3012-17D	CMOS-IC	Voltage detector, 1.75V, Reset Push-pull output	SOT-89	20vde	4b	VD7	Anp
12C	APR3012-23D	CMOS-IC	Voltage detector, 2.32V, Reset Push-pull output	SOT-89	20vde	4b	VD7	Anp
12D	APR3012-26D	CMOS-IC	Voltage detector, 2.63V, Reset Push-pull output	SOT-89	20vde	4b	VD7	Anp
12E	APR3012-29D	CMOS-IC	Voltage detector, 2.93V, Reset Push-pull output	SOT-89	20vde	4b	VD7	Anp
12F	APR3012-30D	CMOS-IC	Voltage detector, 3.08V, Reset Push-pull output	SOT-89	20vde	4b	VD7	Anp
12G	APR3012-39D	CMOS-IC	Voltage detector, 3.9V, Reset Push-pull output	SOT-89	20vde	4b	VD7	Anp
12H	APR3012-43D	CMOS-IC	Voltage detector, 4.38V, Reset Push-pull output	SOT-89	20vde	4b	VD7	Anp
12J	APR3012-46D	CMOS-IC	Voltage detector, 4.63V, Reset Push-pull output	SOT-89	20vde	4b	VD7	Anp
12Y	BZV49-C12	Z-diode	12V±5%, Izt=5mA, 1W	SOT-89	20dm	4b	-	Phi
13A	APR3013-15D	CMOS-IC	Voltage detector, 1.5V, -Reset Open drain output	SOT-89	20vde	4b	VD6	Anp
13B	APR3013-17D	CMOS-IC	Voltage detector, 1.75V, -Reset Open drain output	SOT-89	20vde	4b	VD6	Anp
13C	APR3013-23D	CMOS-IC	Voltage detector, 2.32V, -Reset Open drain output	SOT-89	20vde	4b	VD6	Anp

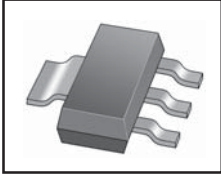

SMD semiconductor components in SOT-223 cases
SMD-codes for semiconductor components in SOT-223
cases

SMD code	Type	Function	Short description	Case	Pin.	St.	Sch.	Mnf.
117-2	NCP1117ST20	VR-IC	LDO, 2V±1%, 800mA	SOT-223	21wb		VR1	Ons
117-5	NCP1117ST50	VR-IC	LDO, 5V±1%, 800mA	SOT-223	21wb		VR1	Ons
117-A	NCP1117STA	VR-IC	LDO, Adjustable, 800mA	SOT-223	21wc		VR20	Ons
17-12	NCP1117ST12	VR-IC	LDO, 12V±1%, 800mA	SOT-223	21wb		VR1	Ons
17-15	NCP1117ST15	VR-IC	LDO, 1.5V±1%, 800mA	SOT-223	21wb		VR1	Ons
17-18	NCP1117ST18	VR-IC	LDO, 1.8V±1%, 800mA	SOT-223	21wb		VR1	Ons
17-25	NCP1117ST25	VR-IC	LDO, 2.5V±1%, 800mA	SOT-223	21wb		VR1	Ons
17-33	NCP1117ST33	VR-IC	LDO, 3.3V±1%, 800mA	SOT-223	21wb		VR1	Ons
1N10	MMFT1N10E	n-MOS-e	V-MOS, 100V, 1A, <0.25Ω(0.5A)	SOT-223	21fi		-	Mot
24K	XC6202P182FR	VR-IC	LDO, 1.8V±2%, 150mA	SOT-223	21ch	5c	VR1	Tor
24L	XC6202P192FR	VR-IC	LDO, 1.9V±2%, 150mA	SOT-223	21ch	5c	VR1	Tor
24M	XC6202P202FR	VR-IC	LDO, 2V±2%, 150mA	SOT-223	21ch	5c	VR1	Tor
24N	XC6202P212FR	VR-IC	LDO, 2.1V±2%, 150mA	SOT-223	21ch	5c	VR1	Tor
24P	XC6202P222FR	VR-IC	LDO, 2.2V±2%, 150mA	SOT-223	21ch	5c	VR1	Tor
24R	XC6202P232FR	VR-IC	LDO, 2.3V±2%, 150mA	SOT-223	21ch	5c	VR1	Tor
24S	XC6202P242FR	VR-IC	LDO, 2.4V±2%, 150mA	SOT-223	21ch	5c	VR1	Tor
24T	XC6202P252FR	VR-IC	LDO, 2.5V±2%, 150mA	SOT-223	21ch	5c	VR1	Tor
24U	XC6202P262FR	VR-IC	LDO, 2.6V±2%, 150mA	SOT-223	21ch	5c	VR1	Tor
24V	XC6202P272FR	VR-IC	LDO, 2.7V±2%, 150mA	SOT-223	21ch	5c	VR1	Tor
24X	XC6202P282FR	VR-IC	LDO, 2.8V±2%, 150mA	SOT-223	21ch	5c	VR1	Tor
24Y	XC6202P292FR	VR-IC	LDO, 2.9V±2%, 150mA	SOT-223	21ch	5c	VR1	Tor
24Z	XC6202P302FR	VR-IC	LDO, 3V±2%, 150mA	SOT-223	21ch	5c	VR1	Tor
250	XC6202P312FR	VR-IC	LDO, 3.1V±2%, 150mA	SOT-223	21ch	5c	VR1	Tor
251	XC6202P322FR	VR-IC	LDO, 3.2V±2%, 150mA	SOT-223	21ch	5c	VR1	Tor
252	XC6202P332FR	VR-IC	LDO, 3.3V±2%, 150mA	SOT-223	21ch	5c	VR1	Tor
253	XC6202P342FR	VR-IC	LDO, 3.4V±2%, 150mA	SOT-223	21ch	5c	VR1	Tor
254	XC6202P352FR	VR-IC	LDO, 3.5V±2%, 150mA	SOT-223	21ch	5c	VR1	Tor
255	XC6202P362FR	VR-IC	LDO, 3.6V±2%, 150mA	SOT-223	21ch	5c	VR1	Tor
256	XC6202P372FR	VR-IC	LDO, 3.7V±2%, 150mA	SOT-223	21ch	5c	VR1	Tor
257	XC6202P382FR	VR-IC	LDO, 3.8V±2%, 150mA	SOT-223	21ch	5c	VR1	Tor
258	XC6202P392FR	VR-IC	LDO, 3.9V±2%, 150mA	SOT-223	21ch	5c	VR1	Tor
259	XC6202P402FR	VR-IC	LDO, 4V±2%, 150mA	SOT-223	21ch	5c	VR1	Tor
25A	XC6202P412FR	VR-IC	LDO, 4.1V±2%, 150mA	SOT-223	21ch	5c	VR1	Tor
25B	XC6202P422FR	VR-IC	LDO, 4.2V±2%, 150mA	SOT-223	21ch	5c	VR1	Tor
25C	XC6202P432FR	VR-IC	LDO, 4.3V±2%, 150mA	SOT-223	21ch	5c	VR1	Tor
25D	XC6202P442FR	VR-IC	LDO, 4.4V±2%, 150mA	SOT-223	21ch	5c	VR1	Tor
25E	XC6202P452FR	VR-IC	LDO, 4.5V±2%, 150mA	SOT-223	21ch	5c	VR1	Tor
25F	XC6202P462FR	VR-IC	LDO, 4.6V±2%, 150mA	SOT-223	21ch	5c	VR1	Tor
25H	XC6202P472FR	VR-IC	LDO, 4.7V±2%, 150mA	SOT-223	21ch	5c	VR1	Tor
25K	XC6202P482FR	VR-IC	LDO, 4.8V±2%, 150mA	SOT-223	21ch	5c	VR1	Tor
25L	XC6202P492FR	VR-IC	LDO, 4.9V±2%, 150mA	SOT-223	21ch	5c	VR1	Tor
25M	XC6202P502FR	VR-IC	LDO, 5V±2%, 150mA	SOT-223	21ch	5c	VR1	Tor
25N	XC6202P512FR	VR-IC	LDO, 5.1V±2%, 150mA	SOT-223	21ch	5c	VR1	Tor
25P	XC6202P522FR	VR-IC	LDO, 5.2V±2%, 150mA	SOT-223	21ch	5c	VR1	Tor
25R	XC6202P532FR	VR-IC	LDO, 5.3V±2%, 150mA	SOT-223	21ch	5c	VR1	Tor
25S	XC6202P542FR	VR-IC	LDO, 5.4V±2%, 150mA	SOT-223	21ch	5c	VR1	Tor
25T	XC6202P552FR	VR-IC	LDO, 5.5V±2%, 150mA	SOT-223	21ch	5c	VR1	Tor
25U	XC6202P562FR	VR-IC	LDO, 5.6V±2%, 150mA	SOT-223	21ch	5c	VR1	Tor
25V	XC6202P572FR	VR-IC	LDO, 5.7V±2%, 150mA	SOT-223	21ch	5c	VR1	Tor
25X	XC6202P582FR	VR-IC	LDO, 5.8V±2%, 150mA	SOT-223	21ch	5c	VR1	Tor
25Y	XC6202P592FR	VR-IC	LDO, 5.9V±2%, 150mA	SOT-223	21ch	5c	VR1	Tor
25Z	XC6202P602FR	VR-IC	LDO, 6V±2%, 150mA	SOT-223	21ch	5c	VR1	Tor
260	XC6202P612FR	VR-IC	LDO, 6.1V±2%, 150mA	SOT-223	21ch	5c	VR1	Tor
261	XC6202P622FR	VR-IC	LDO, 6.2V±2%, 150mA	SOT-223	21ch	5c	VR1	Tor
262	XC6202P632FR	VR-IC	LDO, 6.3V±2%, 150mA	SOT-223	21ch	5c	VR1	Tor
263	XC6202P642FR	VR-IC	LDO, 6.4V±2%, 150mA	SOT-223	21ch	5c	VR1	Tor
264	XC6202P652FR	VR-IC	LDO, 6.5V±2%, 150mA	SOT-223	21ch	5c	VR1	Tor
265	XC6202P662FR	VR-IC	LDO, 6.6V±2%, 150mA	SOT-223	21ch	5c	VR1	Tor
266	XC6202P672FR	VR-IC	LDO, 6.7V±2%, 150mA	SOT-223	21ch	5c	VR1	Tor
267	XC6202P682FR	VR-IC	LDO, 6.8V±2%, 150mA	SOT-223	21ch	5c	VR1	Tor
268	XC6202P692FR	VR-IC	LDO, 6.9V±2%, 150mA	SOT-223	21ch	5c	VR1	Tor
269	XC6202P702FR	VR-IC	LDO, 7V±2%, 150mA	SOT-223	21ch	5c	VR1	Tor
26A	XC6202P712FR	VR-IC	LDO, 7.1V±2%, 150mA	SOT-223	21ch	5c	VR1	Tor
26B	XC6202P722FR	VR-IC	LDO, 7.2V±2%, 150mA	SOT-223	21ch	5c	VR1	Tor
26C	XC6202P732FR	VR-IC	LDO, 7.3V±2%, 150mA	SOT-223	21ch	5c	VR1	Tor
26D	XC6202P742FR	VR-IC	LDO, 7.4V±2%, 150mA	SOT-223	21ch	5c	VR1	Tor
26E	XC6202P752FR	VR-IC	LDO, 7.5V±2%, 150mA	SOT-223	21ch	5c	VR1	Tor
26F	XC6202P762FR	VR-IC	LDO, 7.6V±2%, 150mA	SOT-223	21ch	5c	VR1	Tor
26H	XC6202P772FR	VR-IC	LDO, 7.7V±2%, 150mA	SOT-223	21ch	5c	VR1	Tor
26K	XC6202P782FR	VR-IC	LDO, 7.8V±2%, 150mA	SOT-223	21ch	5c	VR1	Tor
26L	XC6202P792FR	VR-IC	LDO, 7.9V±2%, 150mA	SOT-223	21ch	5c	VR1	Tor
26M	XC6202P802FR	VR-IC	LDO, 8V±2%, 150mA	SOT-223	21ch	5c	VR1	Tor
26N	XC6202P812FR	VR-IC	LDO, 8.1V±2%, 150mA	SOT-223	21ch	5c	VR1	Tor
26P	XC6202P822FR	VR-IC	LDO, 8.2V±2%, 150mA	SOT-223	21ch	5c	VR1	Tor
26R	XC6202P832FR	VR-IC	LDO, 8.3V±2%, 150mA	SOT-223	21ch	5c	VR1	Tor

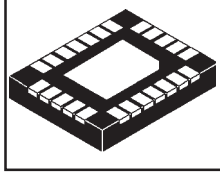
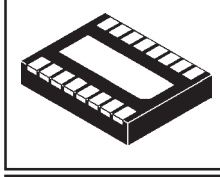
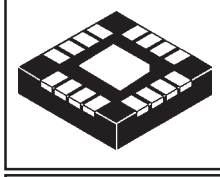
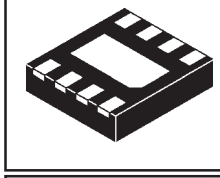
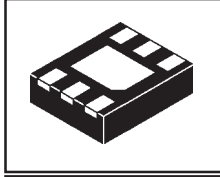
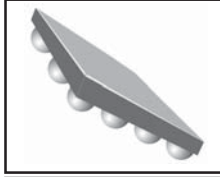
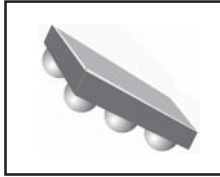

SMD semiconductor components in BGA and LPP cases
SMD-codes for semiconductor components in BGA and LPP cases

SMD code	Type	Function	Short description	Case	Pin.	St.	Sch.	Mnf.
HV	SN74AUP1G07YEPR	CMOS-Log	Noninverting buffer (Open drain output)	BGA-5	Log8	9a		Ti
HV	SN74AUP1G07YZPR	CMOS-Log	Noninverting buffer (Open drain output)	BGA-5	Log8	9a		Ti
HW	SN74AUP1G79YEPR	CMOS-Log	Single D-type flip-flop	BGA-5	Log20	9a	-	Ti
HW	SN74AUP1G79YZPR	CMOS-Log	Single D-type flip-flop	BGA-5	Log20	9a	-	Ti
HX	SN74AUP1G80YEPR	CMOS-Log	Single D-type flip-flop	BGA-5	Log21	9a	-	Ti
HX	SN74AUP1G80YZPR	CMOS-Log	Single D-type flip-flop	BGA-5	Log21	9a	-	Ti
U7	SN74AUC1G17YEAR	CMOS-Log	Schmitt-trigger	BGA-5	Log11	9a	-	Ti
U7	SN74AUC1G17YEPR	CMOS-Log	Schmitt-trigger	BGA-5	Log11	9a	-	Ti
U7	SN74AUC1G17YZAR	CMOS-Log	Schmitt-trigger	BGA-5	Log11	9a	-	Ti
U7	SN74AUC1G17YZPR	CMOS-Log	Schmitt-trigger	BGA-5	Log11	9a	-	Ti
UA	SN74AUC1G00YEAR	CMOS-Log	2-input NAND gate	BGA-5	Log1	9a	-	Ti
UA	SN74AUC1G00YEPR	CMOS-Log	2-input NAND gate	BGA-5	Log1	9a	-	Ti
UA	SN74AUC1G00YZAR	CMOS-Log	2-input NAND gate	BGA-5	Log1	9a	-	Ti
UA	SN74AUC1G00YZPR	CMOS-Log	2-input NAND gate	BGA-5	Log1	9a	-	Ti
UF	SN74AUC1G14YEAR	CMOS-Log	Inverting Schmitt-trigger	BGA-5	Log7	9a	-	Ti
UF	SN74AUC1G14YEPR	CMOS-Log	Inverting Schmitt-trigger	BGA-5	Log7	9a	-	Ti
UF	SN74AUC1G14YZAR	CMOS-Log	Inverting Schmitt-trigger	BGA-5	Log7	9a	-	Ti
UF	SN74AUC1G14YZPR	CMOS-Log	Inverting Schmitt-trigger	BGA-5	Log7	9a	-	Ti
UG	SN74AUC1G32YEAR	CMOS-Log	2-input OR gate	BGA-5	Log4	9a	-	Ti
UG	SN74AUC1G32YEPR	CMOS-Log	2-input OR gate	BGA-5	Log4	9a	-	Ti
UG	SN74AUC1G32YZAR	CMOS-Log	2-input OR gate	BGA-5	Log4	9a	-	Ti
UG	SN74AUC1G32YZPR	CMOS-Log	2-input OR gate	BGA-5	Log4	9a	-	Ti
UK	SN74AUC1G240YEPR	CMOS-Log	Noninverting 3-State Buffer	BGA-5	Log13	9a	-	Ti
UK	SN74AUC1G240YZPR	CMOS-Log	Noninverting 3-State Buffer	BGA-5	Log13	9a	-	Ti
UM	SN74AUC1G125YEAR	CMOS-Log	Noninverting 3-State Buffer	BGA-5	Log14	9a	-	Ti
UM	SN74AUC1G125YEPR	CMOS-Log	Noninverting 3-State Buffer	BGA-5	Log14	9a	-	Ti
UM	SN74AUC1G125YZAR	CMOS-Log	Noninverting 3-State Buffer	BGA-5	Log14	9a	-	Ti
UM	SN74AUC1G125YZPR	CMOS-Log	Noninverting 3-State Buffer	BGA-5	Log14	9a	-	Ti
UN	SN74AUC1G126YEPR	CMOS-Log	Noninverting 3-State Buffer	BGA-5	Log13	9a	-	Ti
UN	SN74AUC1G126YZPR	CMOS-Log	Noninverting 3-State Buffer	BGA-5	Log13	9a	-	Ti
0113	XC6201132DR	VR-IC	1.3V±2%, 250mA	USP-6B	37hs	9b	VR1	Tor
0114	XC6201142DR	VR-IC	1.4V±2%, 250mA	USP-6B	37hs	9b	VR1	Tor
0115	XC6201152DR	VR-IC	1.5V±2%, 250mA	USP-6B	37hs	9b	VR1	Tor
0116	XC6201162DR	VR-IC	1.6V±2%, 250mA	USP-6B	37hs	9b	VR1	Tor
0117	XC6201172DR	VR-IC	1.7V±2%, 250mA	USP-6B	37hs	9b	VR1	Tor
0118	XC6201182DR	VR-IC	1.8V±2%, 250mA	USP-6B	37hs	9b	VR1	Tor
0119	XC6201192DR	VR-IC	1.9V±2%, 250mA	USP-6B	37hs	9b	VR1	Tor
0120	XC6201202DR	VR-IC	2V±2%, 250mA	USP-6B	37hs	9b	VR1	Tor
0121	XC6201212DR	VR-IC	2.1V±2%, 250mA	USP-6B	37hs	9b	VR1	Tor
0122	XC6201222DR	VR-IC	2.2V±2%, 250mA	USP-6B	37hs	9b	VR1	Tor
0123	XC6201232DR	VR-IC	2.3V±2%, 250mA	USP-6B	37hs	9b	VR1	Tor
0124	XC6201242DR	VR-IC	2.4V±2%, 250mA	USP-6B	37hs	9b	VR1	Tor
0125	XC6201252DR	VR-IC	2.5V±2%, 250mA	USP-6B	37hs	9b	VR1	Tor
0126	XC6201262DR	VR-IC	2.6V±2%, 250mA	USP-6B	37hs	9b	VR1	Tor
0127	XC6201272DR	VR-IC	2.7V±2%, 250mA	USP-6B	37hs	9b	VR1	Tor
0128	XC6201282DR	VR-IC	2.8V±2%, 250mA	USP-6B	37hs	9b	VR1	Tor
0129	XC6201292DR	VR-IC	2.9V±2%, 250mA	USP-6B	37hs	9b	VR1	Tor
0130	XC6201302DR	VR-IC	3V±2%, 250mA	USP-6B	37hs	9b	VR1	Tor
0131	XC6201312DR	VR-IC	3.1V±2%, 250mA	USP-6B	37hs	9b	VR1	Tor
0132	XC6201322DR	VR-IC	3.2V±2%, 250mA	USP-6B	37hs	9b	VR1	Tor
0133	XC6201332DR	VR-IC	3.3V±2%, 250mA	USP-6B	37hs	9b	VR1	Tor
0134	XC6201342DR	VR-IC	3.4V±2%, 250mA	USP-6B	37hs	9b	VR1	Tor
0135	XC6201352DR	VR-IC	3.5V±2%, 250mA	USP-6B	37hs	9b	VR1	Tor
0136	XC6201362DR	VR-IC	3.6V±2%, 250mA	USP-6B	37hs	9b	VR1	Tor
0137	XC6201372DR	VR-IC	3.7V±2%, 250mA	USP-6B	37hs	9b	VR1	Tor
0138	XC6201382DR	VR-IC	3.8V±2%, 250mA	USP-6B	37hs	9b	VR1	Tor
0139	XC6201392DR	VR-IC	3.9V±2%, 250mA	USP-6B	37hs	9b	VR1	Tor
0140	XC6201402DR	VR-IC	4V±2%, 250mA	USP-6B	37hs	9b	VR1	Tor
0141	XC6201412DR	VR-IC	4.1V±2%, 250mA	USP-6B	37hs	9b	VR1	Tor
0142	XC6201422DR	VR-IC	4.2V±2%, 250mA	USP-6B	37hs	9b	VR1	Tor
0143	XC6201432DR	VR-IC	4.3V±2%, 250mA	USP-6B	37hs	9b	VR1	Tor
0144	XC6201442DR	VR-IC	4.4V±2%, 250mA	USP-6B	37hs	9b	VR1	Tor
0145	XC6201452DR	VR-IC	4.5V±2%, 250mA	USP-6B	37hs	9b	VR1	Tor
0146	XC6201462DR	VR-IC	4.6V±2%, 250mA	USP-6B	37hs	9b	VR1	Tor
0147	XC6201472DR	VR-IC	4.7V±2%, 250mA	USP-6B	37hs	9b	VR1	Tor
0148	XC6201482DR	VR-IC	4.8V±2%, 250mA	USP-6B	37hs	9b	VR1	Tor
0149	XC6201492DR	VR-IC	4.9V±2%, 250mA	USP-6B	37hs	9b	VR1	Tor
0150	XC6201502DR	VR-IC	5V±2%, 250mA	USP-6B	37hs	9b	VR1	Tor
0151	XC6201512DR	VR-IC	5.1V±2%, 250mA	USP-6B	37hs	9b	VR1	Tor
0152	XC6201522DR	VR-IC	5.2V±2%, 250mA	USP-6B	37hs	9b	VR1	Tor
0153	XC6201532DR	VR-IC	5.3V±2%, 250mA	USP-6B	37hs	9b	VR1	Tor
0154	XC6201542DR	VR-IC	5.4V±2%, 250mA	USP-6B	37hs	9b	VR1	Tor
0155	XC6201552DR	VR-IC	5.5V±2%, 250mA	USP-6B	37hs	9b	VR1	Tor
0156	XC6201562DR	VR-IC	5.6V±2%, 250mA	USP-6B	37hs	9b	VR1	Tor
0157	XC6201572DR	VR-IC	5.7V±2%, 250mA	USP-6B	37hs	9b	VR1	Tor

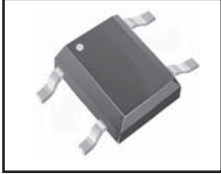
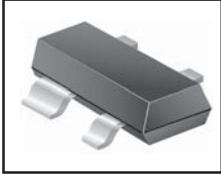

4-pins SMD semiconductor components
SMD-codes for 4-pins cases semiconductor components

SMD code	Type	Function	Short description	Case	Pin. St.	Sch.	Mnf.
01	MRF9011	Si-npn	UHF, 25V, 30mA, 300mW, B=30..200, 3,9GHz	SOT-143	24tc	-	Mot
02	MRF5711	Si-npn	UHF, 20V, 80mA, 580mW, B=50..300, 8GHz	SOT-143	24tc	-	Mot
03	VAM-3	Lin-IC	RF amplifier, DC, 2GHz, 7,5dB (50Ω)	SOT-143	24ad	A1	Mc
04	MRF4427	Si-npn	UHF, 40V, 400mA, 220mW, B=10..200, 1,6GHz	SOT-143	24tc	-	Mot
04	MRF5211	Si-pnp	UHF, 20V, 70mA, 333mW, B=25..125, 4,2GHz	SOT-143	24tc	-	Mot
05	MRF9331	Si-npn	UHF, 15V, 2mA, 50mW, B=30..200, 5GHz	SOT-143	24tc	-	Mot
05F	TSDF1205R	Si-npn	UHF-VHF, LN, 9V, 12mA, 40mW, B=50..250, 12GHz	SOT-143R	26tu	3a	Vs
06	VAM-6	Lin-IC	RF amplifier, DC, 2GHz, 8dB (50Ω)	SOT-143	24ad	A1	Mc
07	VAM-7	Lin-IC	RF amplifier, DC, 2GHz, 7,8dB (50Ω)	SOT-143	24ad	A1	Mc
08	HBFP-0450	Si-npn	UHF, LN, 15V, 100mA, 450mW, B=50..150, 1,8GHz	SOT-343	24t1	-	Agi
0A	BU4317F	CMOS-IC	Voltage Detector 1,7V, Reset Push-pull output	SOP-4	26vdf	VD3	Rhm
0A	R3132Q10EA	CMOS-IC	Voltage Detector 1V, MR, -Reset Push-pull output	SOT-143	24vdh	5a	VD5 Ric
0A	RQ5RW50BA	VR-IC	LDO, CE, 5V±2%, 150mA	SOT-143R	26vp	5a	VR4 Ric
0B	BU4318F	CMOS-IC	Voltage Detector 1,8V, Reset Push-pull output	SOP-4	26vdf	VD3	Rhm
0B	R3132Q11EA	CMOS-IC	Voltage Detector 1,1V, MR, -Reset Push-pull output	SOT-143	24vdh	5a	VD5 Ric
0B	RQ5RW51BA	VR-IC	LDO, CE, 5,1V±2%, 150mA	SOT-143R	26vp	5a	VR4 Ric
0C	BU4319F	CMOS-IC	Voltage Detector 1,9V, Reset Push-pull output	SOP-4	26vdf	VD3	Rhm
0C	R3132Q12EA	CMOS-IC	Voltage Detector 1,2V, MR, -Reset Push-pull output	SOT-143	24vdh	5a	VD5 Ric
0C	RQ5RW52BA	VR-IC	LDO, CE, 5,2V±2%, 150mA	SOT-143R	26vp	5a	VR4 Ric
0D	BU4320F	CMOS-IC	Voltage Detector 2V, Reset Push-pull output	SOP-4	26vdf	VD3	Rhm
0D	R3132Q13EA	CMOS-IC	Voltage Detector 1,3V, MR, -Reset Push-pull output	SOT-143	24vdh	5a	VD5 Ric
0D	RQ5RW53BA	VR-IC	LDO, CE, 5,3V±2%, 150mA	SOT-143R	26vp	5a	VR4 Ric
0E	BU4321F	CMOS-IC	Voltage Detector 2,1V, Reset Push-pull output	SOP-4	26vdf	VD3	Rhm
0E	R3132Q14EA	CMOS-IC	Voltage Detector 1,4V, MR, -Reset Push-pull output	SOT-143	24vdh	5a	VD5 Ric
0E	RQ5RW54BA	VR-IC	LDO, CE, 5,4V±2%, 150mA	SOT-143R	26vp	5a	VR4 Ric
0F	BU4322F	CMOS-IC	Voltage Detector 2,2V, Reset Push-pull output	SOP-4	26vdf	VD3	Rhm
0F	R3132Q15EA	CMOS-IC	Voltage Detector 1,5V, MR, -Reset Push-pull output	SOT-143	24vdh	5a	VD5 Ric
0F	RQ5RW55BA	VR-IC	LDO, CE, 5,5V±2%, 150mA	SOT-143R	26vp	5a	VR4 Ric
0G	BU4323F	CMOS-IC	Voltage Detector 2,3V, Reset Push-pull output	SOP-4	26vdf	VD3	Rhm
0G	R3132Q16EA	CMOS-IC	Voltage Detector 1,6V, MR, -Reset Push-pull output	SOT-143	24vdh	5a	VD5 Ric
0G	RQ5RW56BA	VR-IC	LDO, CE, 5,6V±2%, 150mA	SOT-143R	26vp	5a	VR4 Ric
0H	BU4324F	CMOS-IC	Voltage Detector 2,4V, Reset Push-pull output	SOP-4	26vdf	VD3	Rhm
0H	R3132Q17EA	CMOS-IC	Voltage Detector 1,7V, MR, -Reset Push-pull output	SOT-143	24vdh	5a	VD5 Ric
0H	RQ5RW57BA	VR-IC	LDO, CE, 5,7V±2%, 150mA	SOT-143R	26vp	5a	VR4 Ric
0J	BU4325F	CMOS-IC	Voltage Detector 2,5V, Reset Push-pull output	SOP-4	26vdf	VD3	Rhm
0J	R3132Q18EA	CMOS-IC	Voltage Detector 1,8V, MR, -Reset Push-pull output	SOT-143	24vdh	5a	VD5 Ric
0J	RQ5RW58BA	VR-IC	LDO, CE, 5,8V±2%, 150mA	SOT-143R	26vp	5a	VR4 Ric
0K	BU4326F	CMOS-IC	Voltage Detector 2,6V, Reset Push-pull output	SOP-4	26vdf	VD3	Rhm
0K	R3132Q19EA	CMOS-IC	Voltage Detector 1,9V, MR, -Reset Push-pull output	SOT-143	24vdh	5a	VD5 Ric
0K	RQ5RW59BA	VR-IC	LDO, CE, 5,9V±2%, 150mA	SOT-143R	26vp	5a	VR4 Ric
0L	BU4327F	CMOS-IC	Voltage Detector 2,7V, Reset Push-pull output	SOP-4	26vdf	VD3	Rhm
0L	R3133Q10EA	CMOS-IC	Voltage Detector 1V, MR, Reset Push-pull output	SOT-143	24vdh	5a	VD5 Ric
0M	BU4328F	CMOS-IC	Voltage Detector 2,8V, Reset Push-pull output	SOP-4	26vdf	VD3	Rhm
0M	R3133Q11EA	CMOS-IC	Voltage Detector 1,1V, MR, Reset Push-pull output	SOT-143	24vdh	5a	VD5 Ric
0N	BU4329F	CMOS-IC	Voltage Detector 2,9V, Reset Push-pull output	SOP-4	26vdf	VD3	Rhm
0N	R3133Q12EA	CMOS-IC	Voltage Detector 1,2V, MR, Reset Push-pull output	SOT-143	24vdh	5a	VD5 Ric
0P	BU4330F	CMOS-IC	Voltage Detector 3V, Reset Push-pull output	SOP-4	26vdf	VD3	Rhm
0P	R3133Q13EA	CMOS-IC	Voltage Detector 1,3V, MR, Reset Push-pull output	SOT-143	24vdh	5a	VD5 Ric
0Q	BU4331F	CMOS-IC	Voltage Detector 3,1V, Reset Push-pull output	SOP-4	26vdf	VD3	Rhm
0Q	R3133Q14EA	CMOS-IC	Voltage Detector 1,4V, MR, Reset Push-pull output	SOT-143	24vdh	5a	VD5 Ric
0R	BU4332F	CMOS-IC	Voltage Detector 3,2V, Reset Push-pull output	SOP-4	26vdf	VD3	Rhm
0R	R3133Q15EA	CMOS-IC	Voltage Detector 1,5V, MR, Reset Push-pull output	SOT-143	24vdh	5a	VD5 Ric
0S	BU4333F	CMOS-IC	Voltage Detector 3,3V, Reset Push-pull output	SOP-4	26vdf	VD3	Rhm
0S	R3133Q16EA	CMOS-IC	Voltage Detector 1,6V, MR, Reset Push-pull output	SOT-143	24vdh	5a	VD5 Ric
0T	BU4334F	CMOS-IC	Voltage Detector 3,4V, Reset Push-pull output	SOP-4	26vdf	VD3	Rhm
0T	R3133Q17EA	CMOS-IC	Voltage Detector 1,7V, MR, Reset Push-pull output	SOT-143	24vdh	5a	VD5 Ric
0U	BU4335F	CMOS-IC	Voltage Detector 3,5V, Reset Push-pull output	SOP-4	26vdf	VD3	Rhm
0U	R3133Q18EA	CMOS-IC	Voltage Detector 1,8V, MR, Reset Push-pull output	SOT-143	24vdh	5a	VD5 Ric
0V	BU4336F	CMOS-IC	Voltage Detector 3,6V, Reset Push-pull output	SOP-4	26vdf	VD3	Rhm
0V	R3133Q19EA	CMOS-IC	Voltage Detector 1,9V, MR, Reset Push-pull output	SOT-143	24vdh	5a	VD5 Ric
0W	BU4337F	CMOS-IC	Voltage Detector 3,7V, Reset Push-pull output	SOP-4	26vdf	VD3	Rhm
0X	BU4338F	CMOS-IC	Voltage Detector 3,8V, Reset Push-pull output	SOP-4	26vdf	VD3	Rhm
0Y	BU4339F	CMOS-IC	Voltage Detector 3,9V, Reset Push-pull output	SOP-4	26vdf	VD3	Rhm
0Z	BU4340F	CMOS-IC	Voltage Detector 4V, Reset Push-pull output	SOP-4	26vdf	VD3	Rhm
11	MRF9511A	Si-npn	UHF, 20V, 100mA, 322mW, B=75..150, 8GHz	SOT-143	24tc	-	Mot
12	XC6213B122NR	VR-IC	LDO, CE, 1,2V±2%, 150mA	SSOT-24	26vn	5c	VR4 Tor
13	XC6213B132NR	VR-IC	LDO, CE, 1,3V±2%, 150mA	SSOT-24	26vn	5c	VR4 Tor
14	XC6213B142NR	VR-IC	LDO, CE, 1,4V±2%, 150mA	SSOT-24	26vn	5c	VR4 Tor
15	MRF0211	Si-npn	UHF, 30V, 70mA, 580mW, B=50..300, 5,5GHz	SOT-143	24tc	-	Mot
15	XC6213B152NR	VR-IC	LDO, CE, 1,5V±2%, 150mA	SSOT-24	26vn	5c	VR4 Tor
16	XC6213B162NR	VR-IC	LDO, CE, 1,6V±2%, 150mA	SSOT-24	26vn	5c	VR4 Tor
17	BAS125-07	Si-diode	Dual, Schottky, 25V, 100mA, Vf<0.9V(35mA), Cd<1,1pF	SOT-143	24ce	-	Inf
17	XC6213B172NR	VR-IC	LDO, CE, 1,7V±2%, 150mA	SSOT-24	26vn	5c	VR4 Tor
17	XC6217C082NR	VR-IC	LDO, -CE, 0,8V±2%, 200mA	SSOT-24	26vn	5a	VR4 Tor
18	BFP181T	Si-npn	UHF, 20V, 20mA, 175mW, B=50..200, 8GHz	SOT-143	24tc	-	Tfk

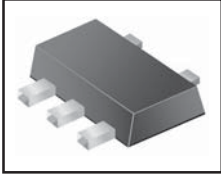
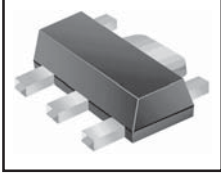
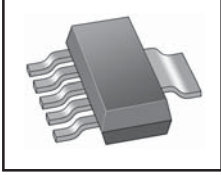

SMD semiconductor components in 5-pins cases
SMD-codes for semiconductor components in 5-pins cases

SMD code	Type	Function	Short description	Case	Pin.	St.	Sch.	Mnf.
00	R1223N252A	VR-IC	PWM/FM St-Dwn DC/DC Conv-Ctrl, CE, 2.5V, 300KHz, L-Pr.	SOT-23-5	28vn	6g	-	Ric
00	RN5RF50BA	VR-IC	LRip, CE, 5V±2%, 1A*	SOT-23-5	28vw	6g	VR6	Ric
00	RN5RZ50BA	VR-IC	Low Noise, LDO, CE, 5V±2%, 100mA	SOT-23-5	28vrt	6g	VR4	Ric
000	XC6101A131MR	CMOS-IC	VDet 3.1V, 5%, Hst. -MR, -Reset PPO, Wt=6.25ms, Rt=3.13ms	SOT-23-5	28xd	6g		Tor
001	XC6101A132MR	CMOS-IC	VDet 3.2V, 5%, Hst. -MR, -Reset PPO, Wt=6.25ms, Rt=3.13ms	SOT-23-5	28xd	6g		Tor
002	XC6101A133MR	CMOS-IC	VDet 3.3V, 5%, Hst. -MR, -Reset PPO, Wt=6.25ms, Rt=3.13ms	SOT-23-5	28xd	6g		Tor
003	XC6101A134MR	CMOS-IC	VDet 3.4V, 5%, Hst. -MR, -Reset PPO, Wt=6.25ms, Rt=3.13ms	SOT-23-5	28xd	6g		Tor
004	XC6101A135MR	CMOS-IC	VDet 3.5V, 5%, Hst. -MR, -Reset PPO, Wt=6.25ms, Rt=3.13ms	SOT-23-5	28xd	6g		Tor
005	XC6101A136MR	CMOS-IC	VDet 3.6V, 5%, Hst. -MR, -Reset PPO, Wt=6.25ms, Rt=3.13ms	SOT-23-5	28xd	6g		Tor
006	XC6101A137MR	CMOS-IC	VDet 3.7V, 5%, Hst. -MR, -Reset PPO, Wt=6.25ms, Rt=3.13ms	SOT-23-5	28xd	6g		Tor
007	XC6101A138MR	CMOS-IC	VDet 3.8V, 5%, Hst. -MR, -Reset PPO, Wt=6.25ms, Rt=3.13ms	SOT-23-5	28xd	6g		Tor
008	R1160N081A	VR-IC	LDO, -CE, 0.8V±2%, 200mA	SOT-23-5	28vrw	6g	VR4	Ric
008	XC6101A139MR	CMOS-IC	VDet 3.9V, 5%, Hst. -MR, -Reset PPO, Wt=6.25ms, Rt=3.13ms	SOT-23-5	28xd	6g		Tor
009	R1160N091A	VR-IC	LDO, -CE, 0.9V±2%, 200mA	SOT-23-5	28vrw	6g	VR4	Ric
009	XC6101A140MR	CMOS-IC	VDet 4.0V, 5%, Hst. -MR, -Reset PPO, Wt=6.25ms, Rt=3.13ms	SOT-23-5	28xd	6g		Tor
00A	XC6101A141MR	CMOS-IC	VDet 4.1V, 5%, Hst. -MR, -Reset PPO, Wt=6.25ms, Rt=3.13ms	SOT-23-5	28xd	6g		Tor
00B	XC6101A142MR	CMOS-IC	VDet 4.2V, 5%, Hst. -MR, -Reset PPO, Wt=6.25ms, Rt=3.13ms	SOT-23-5	28xd	6g		Tor
00C	XC6101A143MR	CMOS-IC	VDet 4.3V, 5%, Hst. -MR, -Reset PPO, Wt=6.25ms, Rt=3.13ms	SOT-23-5	28xd	6g		Tor
00D	XC6101A144MR	CMOS-IC	VDet 4.4V, 5%, Hst. -MR, -Reset PPO, Wt=6.25ms, Rt=3.13ms	SOT-23-5	28xd	6g		Tor
00E	XC6101A145MR	CMOS-IC	VDet 4.5V, 5%, Hst. -MR, -Reset PPO, Wt=6.25ms, Rt=3.13ms	SOT-23-5	28xd	6g		Tor
00F	XC6101A116MR	CMOS-IC	VDet 1.6V, 5%, Hst. -MR, -Reset PPO, Wt=6.25ms, Rt=3.13ms	SOT-23-5	28xd	6g		Tor
00F	XC6101A146MR	CMOS-IC	VDet 4.6V, 5%, Hst. -MR, -Reset PPO, Wt=6.25ms, Rt=3.13ms	SOT-23-5	28xd	6g		Tor
00H	XC6101A117MR	CMOS-IC	VDet 1.7V, 5%, Hst. -MR, -Reset PPO, Wt=6.25ms, Rt=3.13ms	SOT-23-5	28xd	6g		Tor
00H	XC6101A147MR	CMOS-IC	VDet 4.7V, 5%, Hst. -MR, -Reset PPO, Wt=6.25ms, Rt=3.13ms	SOT-23-5	28xd	6g		Tor
00K	XC6101A118MR	CMOS-IC	VDet 1.8V, 5%, Hst. -MR, -Reset PPO, Wt=6.25ms, Rt=3.13ms	SOT-23-5	28xd	6g		Tor
00K	XC6101A148MR	CMOS-IC	VDet 4.8V, 5%, Hst. -MR, -Reset PPO, Wt=6.25ms, Rt=3.13ms	SOT-23-5	28xd	6g		Tor
00L	XC6101A119MR	CMOS-IC	VDet 1.9V, 5%, Hst. -MR, -Reset PPO, Wt=6.25ms, Rt=3.13ms	SOT-23-5	28xd	6g		Tor
00L	XC6101A149MR	CMOS-IC	VDet 4.9V, 5%, Hst. -MR, -Reset PPO, Wt=6.25ms, Rt=3.13ms	SOT-23-5	28xd	6g		Tor
00M	XC6101A120MR	CMOS-IC	VDet 2.0V, 5%, Hst. -MR, -Reset PPO, Wt=6.25ms, Rt=3.13ms	SOT-23-5	28xd	6g		Tor
00M	XC6101A150MR	CMOS-IC	VDet 5.0V, 5%, Hst. -MR, -Reset PPO, Wt=6.25ms, Rt=3.13ms	SOT-23-5	28xd	6g		Tor
00N	XC6101A121MR	CMOS-IC	VDet 2.1V, 5%, Hst. -MR, -Reset PPO, Wt=6.25ms, Rt=3.13ms	SOT-23-5	28xd	6g		Tor
00P	XC6101A122MR	CMOS-IC	VDet 2.2V, 5%, Hst. -MR, -Reset PPO, Wt=6.25ms, Rt=3.13ms	SOT-23-5	28xd	6g		Tor
00R	XC6101A123MR	CMOS-IC	VDet 2.3V, 5%, Hst. -MR, -Reset PPO, Wt=6.25ms, Rt=3.13ms	SOT-23-5	28xd	6g		Tor
00S	XC6101A124MR	CMOS-IC	VDet 2.4V, 5%, Hst. -MR, -Reset PPO, Wt=6.25ms, Rt=3.13ms	SOT-23-5	28xd	6g		Tor
00T	XC6101A125MR	CMOS-IC	VDet 2.5V, 5%, Hst. -MR, -Reset PPO, Wt=6.25ms, Rt=3.13ms	SOT-23-5	28xd	6g		Tor
00U	XC6101A126MR	CMOS-IC	VDet 2.6V, 5%, Hst. -MR, -Reset PPO, Wt=6.25ms, Rt=3.13ms	SOT-23-5	28xd	6g		Tor
00V	XC6101A127MR	CMOS-IC	VDet 2.7V, 5%, Hst. -MR, -Reset PPO, Wt=6.25ms, Rt=3.13ms	SOT-23-5	28xd	6g		Tor
00X	XC6101A128MR	CMOS-IC	VDet 2.8V, 5%, Hst. -MR, -Reset PPO, Wt=6.25ms, Rt=3.13ms	SOT-23-5	28xd	6g		Tor
00Y	XC6101A129MR	CMOS-IC	VDet 2.9V, 5%, Hst. -MR, -Reset PPO, Wt=6.25ms, Rt=3.13ms	SOT-23-5	28xd	6g		Tor
00Z	XC6101A130MR	CMOS-IC	VDet 3.0V, 5%, Hst. -MR, -Reset PPO, Wt=6.25ms, Rt=3.13ms	SOT-23-5	28xd	6g		Tor
01	R1223N152C	VR-IC	PWM St-Dwn DC/DC Cnv-Ctr, CE, 1.5V, 300KHz, Latch-Pr.	SOT-23-5	28vn	6g	-	Ric
01	RN5RF51BA	VR-IC	LRip, CE, 5.1V±2%, 1A*	SOT-23-5	28vw	6g	VR6	Ric
01	RN5RZ51BA	VR-IC	Low Noise, LDO, CE, 5.1V±2%, 100mA	SOT-23-5	28vrt	6g	VR4	Ric
010	R1160N101A	VR-IC	LDO, -CE, 1V±2%, 200mA	SOT-23-5	28vrw	6g	VR4	Ric
010	XC6101A231MR	CMOS-IC	VDet 3.1V, 5%, Hst. -MR, -Reset PPO, Wt=50ms, Rt=3.13ms	SOT-23-5	28xd	6g		Tor
011	R1160N111A	VR-IC	LDO, -CE, 1.1V±2%, 200mA	SOT-23-5	28vrw	6g	VR4	Ric
011	XC6101A232MR	CMOS-IC	VDet 3.2V, 5%, Hst. -MR, -Reset PPO, Wt=50ms, Rt=3.13ms	SOT-23-5	28xd	6g		Tor
012	R1160N121A	VR-IC	LDO, -CE, 1.2V±2%, 200mA	SOT-23-5	28vrw	6g	VR4	Ric
012	XC6101A233MR	CMOS-IC	VDet 3.3V, 5%, Hst. -MR, -Reset PPO, Wt=50ms, Rt=3.13ms	SOT-23-5	28xd	6g		Tor
013	R1160N131A	VR-IC	LDO, -CE, 1.3V±2%, 200mA	SOT-23-5	28vrw	6g	VR4	Ric
013	XC6101A234MR	CMOS-IC	VDet 3.4V, 5%, Hst. -MR, -Reset PPO, Wt=50ms, Rt=3.13ms	SOT-23-5	28xd	6g		Tor
014	R1160N141A	VR-IC	LDO, -CE, 1.4V±2%, 200mA	SOT-23-5	28vrw	6g	VR4	Ric
014	XC6101A235MR	CMOS-IC	VDet 3.5V, 5%, Hst. -MR, -Reset PPO, Wt=50ms, Rt=3.13ms	SOT-23-5	28xd	6g		Tor
015	R1116N151B	VR-IC	LDO, LN, CE, 1.5V±1.5%, 150mA	SOT-23-5	28vx	6g	VR4	Ric
015	R1160N151A	VR-IC	LDO, -CE, 1.5V±2%, 200mA	SOT-23-5	28vrw	6g	VR4	Ric
015	XC6101A236MR	CMOS-IC	VDet 3.6V, 5%, Hst. -MR, -Reset PPO, Wt=50ms, Rt=3.13ms	SOT-23-5	28xd	6g		Tor
016	R1116N161B	VR-IC	LDO, LN, CE, 1.6V±1.5%, 150mA	SOT-23-5	28vx	6g	VR4	Ric
016	R1160N161A	VR-IC	LDO, -CE, 1.6V±2%, 200mA	SOT-23-5	28vrw	6g	VR4	Ric
016	XC6101A237MR	CMOS-IC	VDet 3.7V, 5%, Hst. -MR, -Reset PPO, Wt=50ms, Rt=3.13ms	SOT-23-5	28xd	6g		Tor
017	R1116N171B	VR-IC	LDO, LN, CE, 1.7V±1.5%, 150mA	SOT-23-5	28vx	6g	VR4	Ric
017	R1160N171A	VR-IC	LDO, -CE, 1.7V±2%, 200mA	SOT-23-5	28vrw	6g	VR4	Ric
017	XC6101A238MR	CMOS-IC	VDet 3.8V, 5%, Hst. -MR, -Reset PPO, Wt=50ms, Rt=3.13ms	SOT-23-5	28xd	6g		Tor
018	R1116N181B	VR-IC	LDO, LN, CE, 1.8V±1.5%, 150mA	SOT-23-5	28vx	6g	VR4	Ric
018	R1160N181A	VR-IC	LDO, -CE, 1.8V±2%, 200mA	SOT-23-5	28vrw	6g	VR4	Ric
018	XC6101A239MR	CMOS-IC	VDet 3.9V, 5%, Hst. -MR, -Reset PPO, Wt=50ms, Rt=3.13ms	SOT-23-5	28xd	6g		Tor
019	R1116N191B	VR-IC	LDO, LN, CE, 1.9V±1.5%, 150mA	SOT-23-5	28vx	6g	VR4	Ric
019	R1160N191A	VR-IC	LDO, -CE, 1.9V±2%, 200mA	SOT-23-5	28vrw	6g	VR4	Ric
019	XC6101A240MR	CMOS-IC	VDet 4.0V, 5%, Hst. -MR, -Reset PPO, Wt=50ms, Rt=3.13ms	SOT-23-5	28xd	6g		Tor
01A	APR3001-15B	CMOS-IC	Voltage detector, 1.5V, -Reset Push-pull output	SOT-23-5	28vdm	3b	VD7	Anp
01A	XC6101A241MR	CMOS-IC	VDet 4.1V, 5%, Hst. -MR, -Reset PPO, Wt=50ms, Rt=3.13ms	SOT-23-5	28xd	6g		Tor
01B	APR3001-17B	CMOS-IC	Voltage detector, 1.75V, -Reset Push-pull output	SOT-23-5	28vdm	3b	VD7	Anp
01B	XC6101A242MR	CMOS-IC	VDet 4.2V, 5%, Hst. -MR, -Reset PPO, Wt=50ms, Rt=3.13ms	SOT-23-5	28xd	6g		Tor
01C	APR3001-23B	CMOS-IC	Voltage detector, 2.32V, -Reset Push-pull output	SOT-23-5	28vdm	3b	VD7	Anp
01C	R1182N121B	VR-IC	LDO, CE, 1.2V±2%, 150mA	SOT-23-5	28vrt	6g	VR4	Ric
01C	XC6101A243MR	CMOS-IC	VDet 4.3V, 5%, Hst. -MR, -Reset PPO, Wt=50ms, Rt=3.13ms	SOT-23-5	28xd	6g		Tor

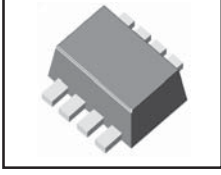
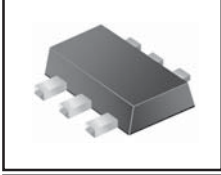
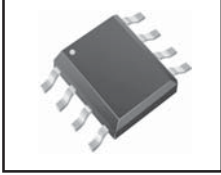
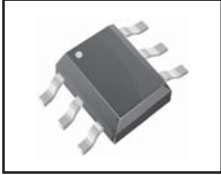

SMD semiconductor components in 6- and more pins cases
SMD-codes for semiconductor components in 6- and more pins cases





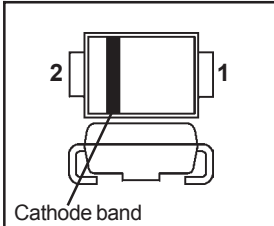
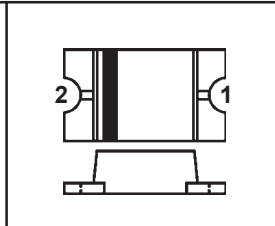
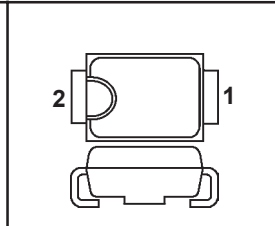
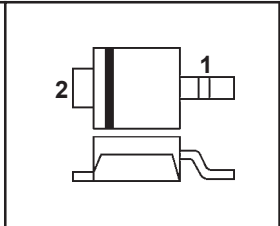
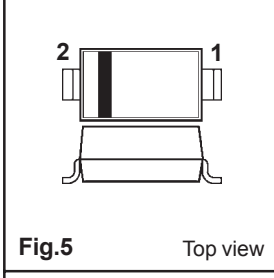
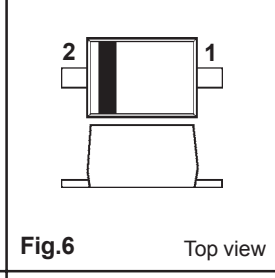
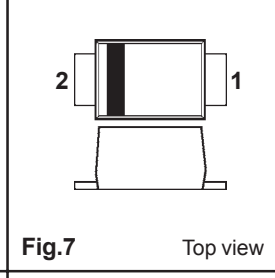
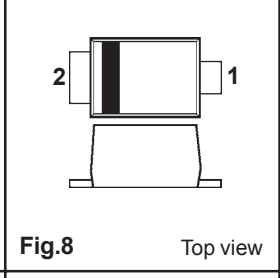
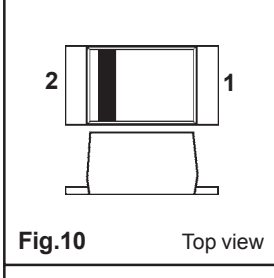
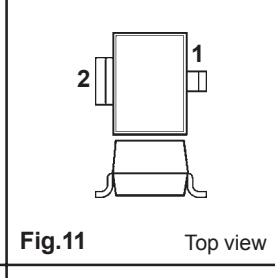
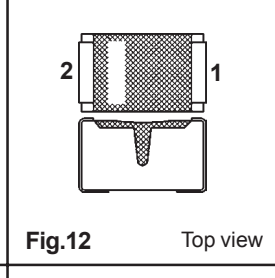
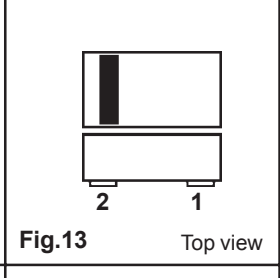
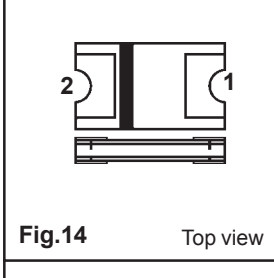
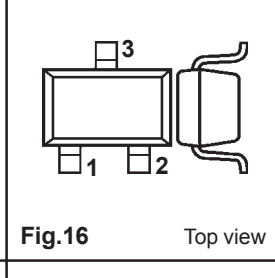
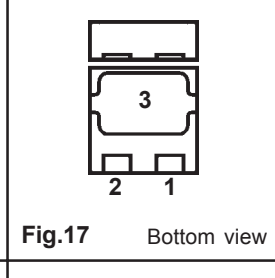
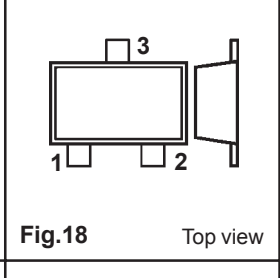
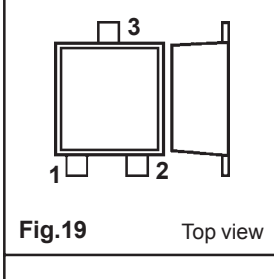
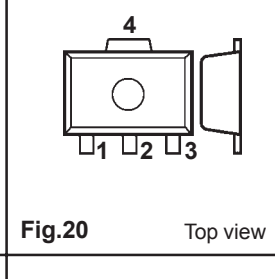
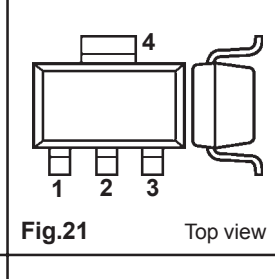
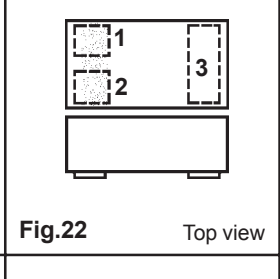
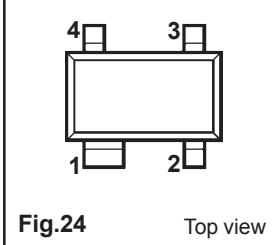
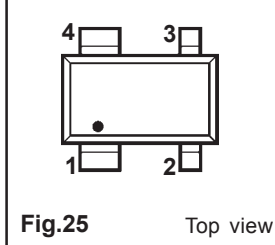
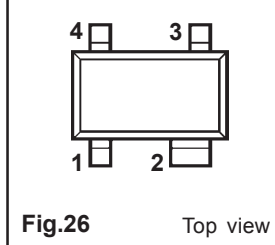
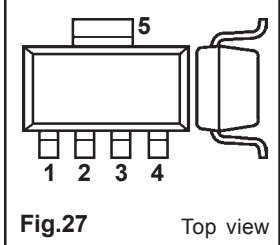



















SMD code	Type	Function	Short description	Case	Pin.	St.	Sch.	Mnf.
005	FAN7005MU	Lin-IC	2xAF PA, 2.7..5.5V, 2x300mW(5V/8Q), shutdown	MINISO-8	33	PA16	F	
005	FAN7005MX	Lin-IC	2xAF PA, 2.7..5.5V, 2x300mW(5V/8Q), shutdown	SO-8	33	PA15	F	
024	FAN7024MU(MUX)	Lin-IC	AF PA, BTL, 2.3..5.5V, 675mW(5V/8Q), shutdown	MINISO-8	33	PA11	F	
05	R1163D151E	VR-IC	LDO, CE, 1.5V±1.5%, 150mA	SON-6	35vrc	7g VR10	Ric	
05/50	SMS05	TVS	Quad, 5V, 24A, 350W(1ms)	SOT-23-6L	33xd	7b -	Smt	
06	R1163D161E	VR-IC	LDO, CE, 1.6V±1.5%, 150mA	SON-6	35vrc	7g VR10	Ric	
06H	MUN5131DW	Si-pnp-Digi	Dual, Sw, 2x50V, 100mA, 400mW, R1/R2=2k2/2k2	SOT-363	33tg	-	Mot	
07	R1163D171E	VR-IC	LDO, CE, 1.7V±1.5%, 150mA	SON-6	35vrc	7g VR10	Ric	
08	R1163D181E	VR-IC	LDO, CE, 1.8V±1.5%, 150mA	SON-6	35vrc	7g VR10	Ric	
09	R1163D191E	VR-IC	LDO, CE, 1.9V±1.5%, 150mA	SON-6	35vrc	7g VR10	Ric	
0A	MUN5111DW	Si-pnp-Digi	Dual, Sw, 2x50V, 100mA, 400mW, R1/R2=10/10k	SOT-363	33tg	-	Mot	
0A	R1161D281A5	VR-IC	LDO, -CE, 2.85V±2%, 350mA	SON-6	35vrc	7g VR10	Ric	
0A	R5326N001B	VR-IC	LDO, Dual out, sep. CE, Vo1=2V, Vo2=2V, 150mA	SOT-23-6	33rg	7f	Ric	
0B	MUN5112DW	Si-pnp-Digi	Dual, Sw, 2x50V, 100mA, 400mW, R1/R2=22/22k	SOT-363	33tg	-	Mot	
0B	R1161D101A	VR-IC	LDO, -CE, 1V±2%, 350mA	SON-6	35vrc	7g VR10	Ric	
0B	R5326N002B	VR-IC	LDO, Dual out, sep. CE, Vo1=2.8V, Vo2=2.8V, 150mA	SOT-23-6	33rg	7f	Ric	
0C	MUN5113DW	Si-pnp-Digi	Dual, Sw, 2x50V, 100mA, 400mW, R1/R2=47k/47k	SOT-363	33tg	-	Mot	
0C	R1161D201A	VR-IC	LDO, -CE, 2V±2%, 350mA	SON-6	35vrc	7g VR10	Ric	
0C	R5326N003B	VR-IC	LDO, Dual out, sep. CE, Vo1=1.8V, Vo2=3V, 150mA	SOT-23-6	33rg	7f	Ric	
0D	MUN5114DW	Si-pnp-Digi	Dual, Sw, 2x50V, 100mA, 400mW, R1/R2=10/47k	SOT-363	33tg	-	Mot	
0D	R1161D301A	VR-IC	LDO, -CE, 3V±2%, 350mA	SON-6	35vrc	7g VR10	Ric	
0D	R5326N004B	VR-IC	LDO, Dual out, sep. CE, Vo1=2.5V, Vo2=3V, 150mA	SOT-23-6	33rg	7f	Ric	
0E	MUN5115DW	Si-pnp-Digi	Dual, Sw, 2x50V, 100mA, 400mW, R1=10k	SOT-363	33tg	-	Mot	
0E	R1161D281B	VR-IC	LDO, CE, 2.8V±2%, 350mA	SON-6	35vrc	7g VR10	Ric	
0E	R5326N005B	VR-IC	LDO, Dual out, sep. CE, Vo1=1.8V, Vo2=2.5V, 150mA	SOT-23-6	33rg	7f	Ric	
0F	MUN5116DW	Si-pnp-Digi	Dual, Sw, 2x50V, 100mA, 400mW, R1=4k7	SOT-363	33tg	-	Mot	
0F	R1161D101B	VR-IC	LDO, CE, 1V±2%, 350mA	SON-6	35vrc	7g VR10	Ric	
0F	R5326N006B	VR-IC	LDO, Dual out, sep. CE, Vo1=1.8V, Vo2=3.3V, 150mA	SOT-23-6	33rg	7f	Ric	
0G	MUN5130DW	Si-pnp-Digi	Dual, Sw, 2x50V, 100mA, 400mW, R1/R2=1k/1k0	SOT-363	33tg	-	Mot	
0G	R1161D201B	VR-IC	LDO, CE, 2V±2%, 350mA	SON-6	35vrc	7g VR10	Ric	
0G	R5326N007B	VR-IC	LDO, Dual out, sep. CE, Vo1=2.5V, Vo2=2.8V, 150mA	SOT-23-6	33rg	7f	Ric	
0H	R1161D301B	VR-IC	LDO, CE, 3V±2%, 350mA	SON-6	35vrc	7g VR10	Ric	
0H	R5326N008B	VR-IC	LDO, Dual out, sep. CE, Vo1=1.2V, Vo2=1.2V, 150mA	SOT-23-6	33rg	7f	Ric	
0J	MUN5132DW	Si-pnp-Digi	Dual, Sw, 2x50V, 100mA, 400mW, R1/R2=4k/4k7	SOT-363	33tg	-	Mot	
0J	R1161D101D	VR-IC	LDO, CE, auto discharge, 1V±2%, 350mA	SON-6	35vrc	7g VR10	Ric	
0J	R1161D281D	VR-IC	LDO, CE, auto discharge, 2.8V±2%, 350mA	SON-6	35vrc	7g VR10	Ric	
0J	R5326N009B	VR-IC	LDO, Dual out, sep. CE, Vo1=1.5V, Vo2=1.6V, 150mA	SOT-23-6	33rg	7f	Ric	
0K	MUN5133DW	Si-pnp-Digi	Dual, Sw, 2x50V, 100mA, 400mW, R1/R2=4k7/47k	SOT-363	33tg	-	Mot	
0K	R5326N010B	VR-IC	LDO, Dual out, sep. CE, Vo1=1.5V, Vo2=2.8V, 150mA	SOT-23-6	33rg	7f	Ric	
0L	MUN5134DW	Si-pnp-Digi	Dual, Sw, 2x50V, 100mA, 400mW, R1/R2=22k/47k	SOT-363	33tg	-	Mot	
0L	R1161D201D	VR-IC	LDO, CE, auto discharge, 2V±2%, 350mA	SON-6	35vrc	7g VR10	Ric	
0L	R5326N011B	VR-IC	LDO, Dual out, sep. CE, Vo1=3V, Vo2=3V, 150mA	SOT-23-6	33rg	7f	Ric	
0M	R1161D301D	VR-IC	LDO, CE, auto discharge, 3V±2%, 350mA	SON-6	35vrc	7g VR10	Ric	
0M	R5326N012B	VR-IC	LDO, Dual out, sep. CE, Vo1=3.1V, Vo2=3.1V, 150mA	SOT-23-6	33rg	7f	Ric	
0N	MUN5136DW	Si-pnp-Digi	Dual, Sw, 2x50V, 100mA, 400mW, R1/R2=100k/100k	SOT-363	33tg	-	Mot	
0N	R5326N013B	VR-IC	LDO, Dual out, sep. CE, Vo1=2.7V, Vo2=1.8V, 150mA	SOT-23-6	33rg	7f	Ric	
0P	MUN5137DW	Si-pnp-Digi	Dual, Sw, 2x50V, 100mA, 400mW, R1/R2=47k/22k	SOT-363	33tg	-	Mot	
0P	R5326N014B	VR-IC	LDO, Dual out, sep. CE, Vo1=1.8V, Vo2=2.6V, 150mA	SOT-23-6	33rg	7f	Ric	
0Q	R5326N015B	VR-IC	LDO, Dual out, sep. CE, Vo1=3.3V, Vo2=3.3V, 150mA	SOT-23-6	33rg	7f	Ric	
0R	R5326N016B	VR-IC	LDO, Dual out, sep. CE, Vo1=2.85V, Vo2=2.85V, 150mA	SOT-23-6	33rg	7f	Ric	
10	R1163D201E	VR-IC	LDO, CE, 2V±1.5%, 150mA	SON-6	35vrc	7g VR10	Ric	
105	FC105	Si-pnp-Digi	Dual, Sw, 50V, 100mA, 200mW, 200MHz, R1/R2=47k/47k	SOT-363	33tg	-	Say	
106	FC106	Si-pnp-Digi	Dual, Sw, 50V, 100mA, 200mW, 200MHz, R1/R2=47k/47k	SOT-363	TD3	-	Say	
10N02Z	MMSF10N02Z	n-MOS*+e	V-MOS, LogL, 20V, 7A, 2.5W, <16mΩ(5A), 65/325ns	SO-8	33fs	7b -	Ons	
11	MUN5311DW	Si-n/p-Digi	Dual, Sw, 50V, 100mA, 200mW, R1/R2=10/10k	SOT-363	33tc	-	Mot	
11	R1163D211E	VR-IC	LDO, CE, 2.1V±1.5%, 150mA	SON-6	35vrc	7g VR10	Ric	
12	MUN5312DW	Si-n/p-Digi	Dual, Sw, 50V, 100mA, 200mW, R1/R2=22/22k	SOT-363	33tc	-	Mot	
12	R1163D221E	VR-IC	LDO, CE, 2.2V±1.5%, 150mA	SON-6	35vrc	7g VR10	Ric	
12/Z1	SMS12	TVS	Quad, 12V, 15A, 350W(1ms)	SOT-23-6L	33xd	7b -	Smt	
12A	MMQA12V	TVS	Quad, 12V, 24W(1ms)	SC-74	33dx	7b -	Ons	
13	MUN5313DW	Si-n/p-Digi	Dual, Sw, 50V, 100mA, 200mW, R1/R2=47k/47k	SOT-363	33tc	-	Mot	
13	R1163D231E	VR-IC	LDO, CE, 2.3V±1.5%, 150mA	SON-6	35vrc	7g VR10	Ric	
13A	MMQA13V1	TVS	Quad, 13V, 24W(1ms)	SC-74	33dx	7b -	Ons	
13A	TK74013L	VR-IC	Dual, LDO, Separate CE, 1.3+1.3V±2%, 300mA	SOT-23L-8	33uh	-	Tok	
13F	BC847BPDW	Si-n/p	Dual, GP, 50V, 100mA, 250mW, B=200..450, >100MHz	SOT-363	33td	-	Ons	
13G	BC847CPDW	Si-n/p	Dual, GP, 50V, 100mA, 250mW, B=420..800, >100MHz	SOT-363	33td	-	Ons	
13K	BC848BPDW	Si-n/p	Dual, GP, 30V, 100mA, 250mW, B=200..450, >100MHz	SOT-363	33td	-	Ons	
13L	BC848CPDW	Si-n/p	Dual, GP, 30V, 100mA, 250mW, B=420..800, >100MHz	SOT-363	33td	-	Ons	
13P	TK11213BM	VR-IC	LDO, CE, 1.3V±2%, 150mA	SOT-23L-6	33vf	7b VR7	Tok	
13t	BC847BPN	Si-n/p	Dual, GP, 50V, 100mA, 200mW, B=200..450, >100MHz	SOT-363	33td	-	Phi	
14	MUN5314DW	Si-n/p-Digi	Dual, Sw, 50V, 100mA, 200mW, R1/R2=10/47k	SOT-363	33tc	-	Mot	
14	R1163D241E	VR-IC	LDO, CE, 2.4V±1.5%, 150mA	SON-6	35vrc	7g VR10	Ric	
1460A1	LT1460ACS8-10	Vref-IC	µPower, Precision, Series, 10V, 0.075%	S8	33af	VR1	Ltc	
1460A2	LT1460ACS8-2.5	Vref-IC	µPower, Precision, Series, 2.5V, 0.075%	S8	33af	VR1	Ltc	
1460A5	LT1460ACS8-5	Vref-IC	µPower, Precision, Series, 5V, 0.075%	S8	33af	VR1	Ltc	

Conventional cases drawings
Cases pin assignments
Pinouts

 <p>Cathode band</p> <p>Fig.1 Top view</p>	 <p>Fig.2 Top view</p>	 <p>Fig.3 Top view</p>	 <p>Fig.4 Top view</p>
 <p>Fig.5 Top view</p>	 <p>Fig.6 Top view</p>	 <p>Fig.7 Top view</p>	 <p>Fig.8 Top view</p>
 <p>Fig.10 Top view</p>	 <p>Fig.11 Top view</p>	 <p>Fig.12 Top view</p>	 <p>Fig.13 Top view</p>
 <p>Fig.14 Top view</p>	 <p>Fig.16 Top view</p>	 <p>Fig.17 Bottom view</p>	 <p>Fig.18 Top view</p>
 <p>Fig.19 Top view</p>	 <p>Fig.20 Top view</p>	 <p>Fig.21 Top view</p>	 <p>Fig.22 Top view</p>
 <p>Fig.24 Top view</p>	 <p>Fig.25 Top view</p>	 <p>Fig.26 Top view</p>	 <p>Fig.27 Top view</p>

	1	2	3	4	5	6	7	8
a	X	X						
aa	Input	GND	Vcc/Output					
ab	Input	GND	GND	Output	GND	Vcc		
ac	Vcc	GND	Input	GND	GND	Output	GND	GND
ad	Input	GND	Vcc/Output	GND				
ae	Input	Vcc	GND	Output	GND	GND		
af	N/C	Vinput	N/C	GND	N/C	Voutput	N/C	N/C
ag	Contact	Contact	N/C					
ak	N/C	K	A					
am	Vcc/Output	GND	Input	GND				
ba	K(A)	K(A)						
bb	K1	K2	K3	A3	A2	A1		
bc	K1	Common A	K2	K3	K4			
be	K1	K2	A3/A4	K3	K4	A1/A2		
bf	K1	Common A	K2	K3	K4	K5		
bg	K1	K2	A2	N/C	A1			
bh	A1	Common K	A2	A3	A4			
bi	A	K	A	A	K	A		
bj	A1	A2	K3/K4	A3	A4	K1/K2		
bk	A1	K2	K3/A4	A3	K4	K1/A2		
bn	OVP	Vinput	CE	AGND	N/C	Feedback	SW	PGND
bp	K	K	A	A	K	K		
bq	GND	Voutput	Lx					
br	GND	Voutput	Ext					
bs	A1	Common K	A2	Common K				
bt	K1	N/C	K2	Common A				
bu	A1	N/C	A2	Common K				
bv	A1	N/C	K2	K1/A2				
bw	A1	Common K	A2	A3	Common K	A4		
bx	A1	K1/A2	K2	K3	A3/K4	A4		
by	K1	A1/K2	A2	K3	A3/K4	A4		
bz	K	A	K					
c	K1	Common A	K2	K3	N/C	K4		
ca	Q	GND	+Input	-Input	Output			
cb	Vcc	Shutdown	Input L	Output L	GND	Output R	Input R	Cext
cd	K1/A2/K3	K2	A3	A1				
ce	K1	K2	A2	A1				
cf	GND	Vinput	Vinput	Vinput	Voutput	Voutput	Voutput	N/C
cg	GND	Voutput	Vinput					
ch	Voutput	GND	Vinput					
cj	Voutput	Vinput	GND					
ck	Voutput	Adjust	Vinput					
cm	Adjust	Vinput	Voutput					
cn	Adjust	Voutput	Vinput					
co	±Reset	±MR	Vcc	GND				
cp	-Reset	GND	-MR	WDI	Vcc			
cq	±Reset	GND	±MR1	Vcc	±MR2			
cs	A1	K1	A2	K2				
ct	A1	K1	K2	A2				
cu	Vinput	GND	±CE	Shutdown	Voutput			
cv	Voutput	Shutdown	±CE	Vinput				
cw	Shutdown	GND	±CE	Vinput	Voutput			
d	A	K						
da	A1/K4	A2/K1	A3/K2	A4/K3				
db	A1	K1/A2	K2	N/C				

SMD-codes marking style

<p>1a</p>  <p>SMD code</p>	<p>1b</p>  <p>SMD code</p>	<p>1c</p>  <p>SMD code Lot number</p>	<p>1d</p>  <p>SMD code Data code (Y-Year, M-month)</p>
<p>1e</p>  <p>SMD code</p>	<p>1f</p>  <p>SMD code Assembly location Data code (Y-Year, W-week) Wafer lot</p>	<p>1g</p>  <p>SMD code Data code</p>	<p>1h</p>  <p>SMD code Data code</p>
<p>1i</p>  <p>SMD code Data code (N-Year, M-month)</p>	<p>1j</p>  <p>SMD code</p>	<p>1k</p>  <p>Manufacturer logo SMD code Data code (N-Year, M-month)</p>	<p>1l</p>  <p>Manufacturer logo SMD code Data code (N-Year, M-month)</p>
<p>1m</p>  <p>Manufacturer logo SMD code Data code</p>	<p>1n</p>  <p>SMD code Manufacturer logo</p>	<p>1p</p>  <p>SMD code Manufacturer logo</p>	<p>1q</p>  <p>Manufacturer logo SMD code Data code (Y-Year, M-month)</p>
<p>1r</p>  <p>Manufacturer logo SMD code Data code (Y-Year, M-month)</p>	<p>1s</p>  <p>SMD code Data code (Y-Year, W-week)</p>	<p>1t</p>  <p>SMD code</p>	<p>1u</p>  <p>SMD code Data code</p>
<p>1v</p>  <p>SMD code</p>	<p>1w</p>  <p>Manufacturer logo SMD code</p>	<p>1x</p>  <p>Manufacturer logo SMD code Data code</p>	<p>1y</p>  <p>Manufacturer logo SMD code</p>

Sample schematics diagrams

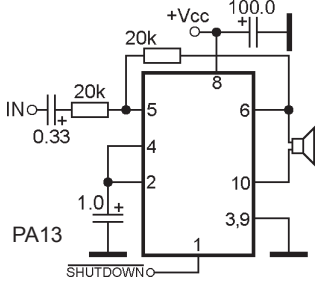
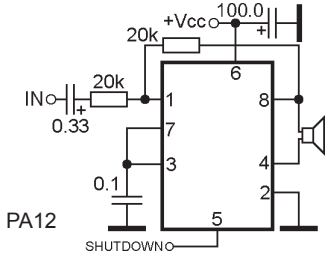
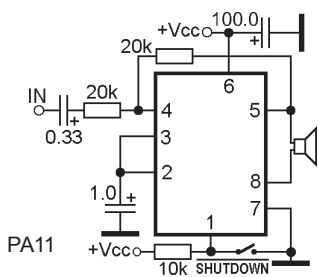
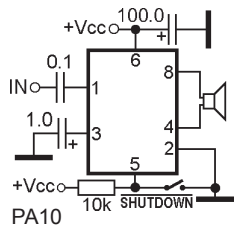
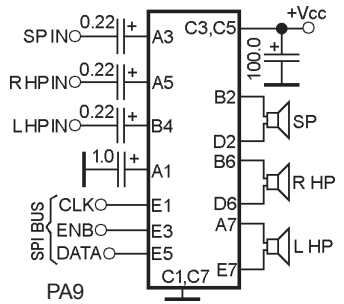
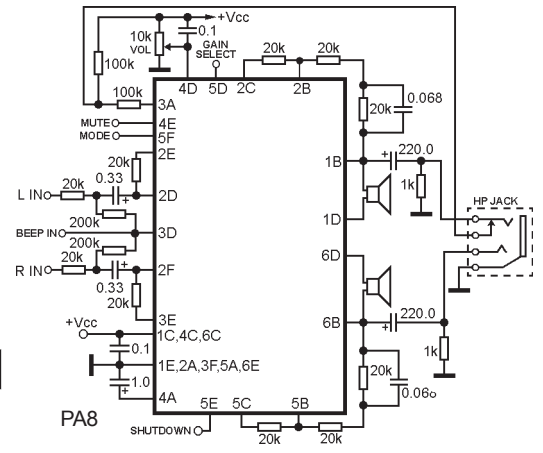
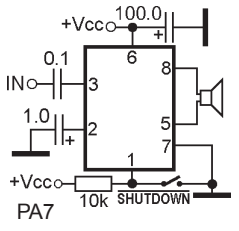
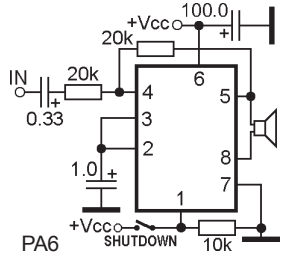
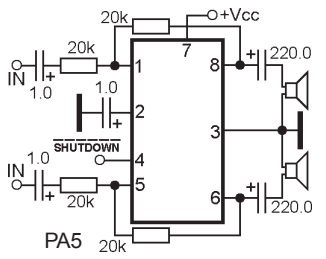
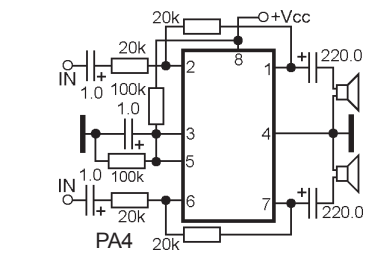
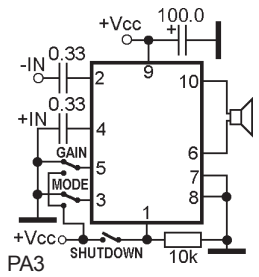
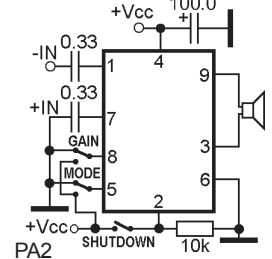
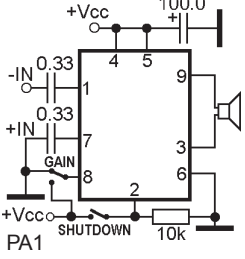
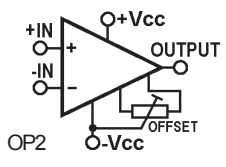
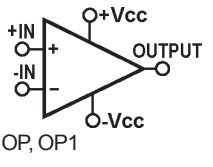
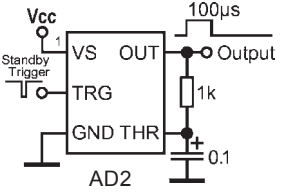
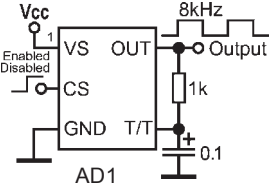
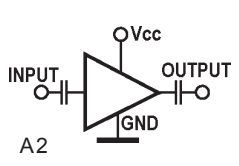
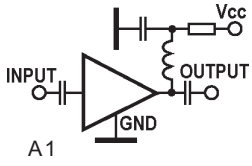

Logos, contact and web-adresses of the manufacturers



Agi- Agilent Technologies

395 Page Mill Rd. Palo Alto, CA 94306 USA, Phone: +1 (877) 424-4536
www.semiconductor.agilent.com



Aic- Analog Integrations Corporation

3A1, No.1, Li-Hsin Rd. I, Science Park, Hsinchu 300, Taiwan, R.O.C.
<http://www.analog.com.tw>



Ali- Alliance Semiconductor

12575 Augustine Drive, Santa Clara, CA 95054, USA, Phone: +1-408.855.4900
<http://www.alsc.com>



All- Allegro MicroSystems Inc.

115 Northeast Cutoff, Box 15036 Worcester, MA 01615, USA, Phone: +1-508-853-5000
<http://www.allegromicro.com>



Ame- AME, Inc.

2F, 189 Kang-Chien Road, Nei-Hu Dist. Taipei 114 Taiwan, R.O.C., Phone: 886 2 2627-8687
www.ame.com.tw



Ana- Anachip Corp.

2F, No.24-2, Industry E. Rd. IV, Science-Based Industrial Park, Hsinchu 300, Taiwan
Phone: +886-3-5678234
www.anachip.com.tw



And- Analog Devices

One Technology Way, Norwood, MA 02062, USA, Phone: 781/329-4700
<http://www.analog.com>



Ant- Advanced Analogic Technologies, Inc.

830 E. Arques Avenue, Sunnyvale, CA 94085, USA, Phone: (408) 737-4600
<http://www.analogictech.com>



Atr- Aimtron

2F, No.10, Prosperity RD. II, Science-Based Industrial Park, Hsinchu 300, Taiwan, R.O.C.
Phone: 886-3-563-0878
<http://www.aimtron.com.tw>



Auk- AUK Semiconductor Corp.

Shinheung-dong, Iksan, Jeollabuk-do, Korea, Phone: 063-835-7111
<http://www.auk.co.kr>



Bub- Burr-Brown Corp.

PO Box 11400, 6730 S. Tucson Blvd., Tucson, AZ 85706 USA, Phone: 520/746-7365
<http://www.burr-brown.com>



Cdi- Continental Device India Limited

C-120, Naraina Industrial Area, New Delhi 110028, India, Phone: 91-11-5796150-63
<http://www.cdil.com>



Cel- California Eastern Laboratories

4590 Patrick Henry Drive, Santa Clara, CA 95054-1817, USA, Phone: (408) 988-3500
<http://www.cel.com>



Cen- Central Semiconductor Corp.

1145 Adams Avenue, Hauppauge, NY 11788, USA, Phone: 516/435-1110
<http://www.centalsemi.com>

©Turuta Eugene

Negruzzi blvd. 5, ap.15, Chisinau, 2001MD, Republic of Moldova