

MFC8020A
MFC8021A
MFC8022A

DEVICES DISCONTINUED – CONSULT FACTORY

CLASS B AUDIO DRIVERS

... designed as preamplifiers and driver circuits for complementary output transistors.

- Driver for Auto Radios – and up to 20-Watt Amplifiers
- High Gain – 7.0 mV for 1.0 Watt, $R_L = 3.2$ Ohms
- High Input Impedance – 500-Kilohm Capability
- Output Biasing Diodes Included
- No Special hFE Matching of Outputs Required

CLASS B AUDIO DRIVERS
SILICON MONOLITHIC
FUNCTIONAL CIRCUITS

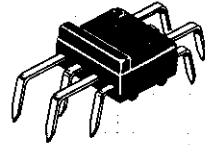

CASE 644A
 PLASTIC PACKAGE

MAXIMUM RATINGS ($T_A = +25^\circ\text{C}$ unless otherwise noted.)

Rating	Value			Unit
	MFC8020A	MFC8021A	MFC8022A	
Power Supply Voltage	35	20	45	Vdc
Power Dissipation	1.0	1.0	1.0	Watt
Derate above $T_A = +25^\circ\text{C}$	10	10	10	mW/ $^\circ\text{C}$
Peak Output Current (pins 5 & 8)	150	150	150	mA
Operating Temperature Range	-10 to +75	-10 to +75	-10 to +75	$^\circ\text{C}$
Storage Temperature Range	-55 to +125	-55 to +125	-55 to +125	$^\circ\text{C}$

THERMAL CHARACTERISTICS

Characteristic	Value	Unit
Thermal Resistance	100	$^\circ\text{C}/\text{W}$
Junction Temperature	125	$^\circ\text{C}$

FIGURE 1 – CIRCUIT SCHEMATIC

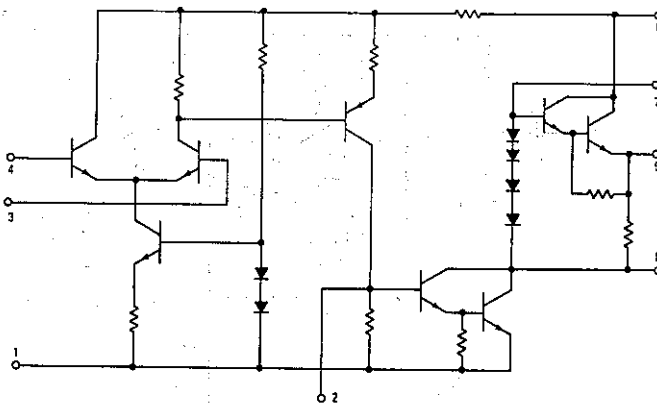

See Packaging Information Section for outline dimensions.

MFC8020A, MFC8021A, MFC8022A (continued)

YAN 1984 7 15X00 - 114M7104A11 1000127

ELECTRICAL CHARACTERISTICS (T_A = +25°C unless otherwise noted) (See Figure 2)

Characteristic	Min	Typ	Max	Unit
Drain Current (e _{in} = 0) V _{CC} = 30 Vdc MFC8020A V _{CC} = 14 Vdc MFC8021A V _{CC} = 40 Vdc MFC8022A	—	10 7.0 12	30 30 30	mA
Sensitivity (P _O = 1.0 Watt, f = 1.0 kHz) e _o = 8.95 V(RMS), R _L = 165 Ω MFC8020A e _o = 3.2 V(RMS), R _L = 65 Ω MFC8021A e _o = 12.65 V(RMS), R _L = 165 Ω MFC8022A	—	89 32 126	112 40 160	mV
Total Harmonic Distortion (f = 1.0 kHz) V _{CC} = 30 V, e _o = 8.95 V(RMS), R _L = 165 Ω MFC8020A V _{CC} = 14 V, e _o = 3.2 V(RMS), R _L = 65 Ω MFC8021A V _{CC} = 40 V, e _o = 12.65 V(RMS), R _L = 165 Ω MFC8022A	—	0.7 1.0 1.5	5.0 5.0 5.0	%
Open-Loop Gain V _{CC} = 30 V, R _L = 165 Ω MFC8020A V _{CC} = 14 V, R _L = 65 Ω MFC8021A V _{CC} = 40 V, R _L = 165 Ω MFC8022A	—	89 87 90	—	dB
Ripple Rejection f = 60 Hz, A _v = 100, e _{in} = 0, Power Supply Ripple = 1.0 V(RMS)	—	27	—	dB
Equivalent Input Noise e _{in} = 0, R _S = 1.0 k Ω, BW = 100 Hz - 10 kHz	—	18	—	μV
Quiescent Output Voltage (e _{in} = 0) V _{CC} = 30 V MFC8020A V _{CC} = 14 V MFC8021A V _{CC} = 40 V MFC8022A	—	15 7.0 20	—	Vdc

FIGURE 2 - TEST CIRCUIT

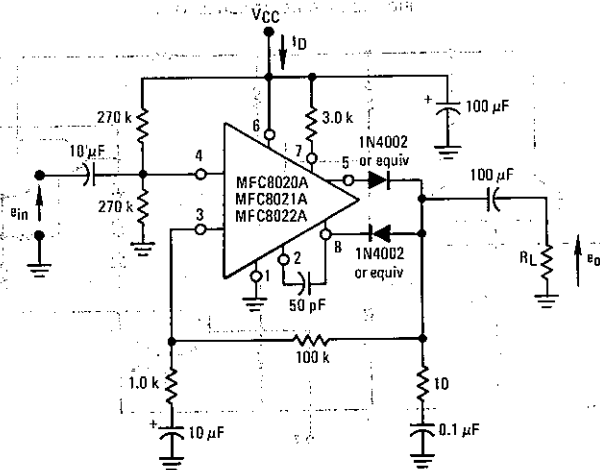

8

TYPICAL AUTO RADIO AUDIO APPLICATION and CHARACTERISTICS

($T_A = +25^{\circ}\text{C}$ unless otherwise noted.)

FIGURE 3 - APPLICATION CIRCUIT FOR MFC8021A

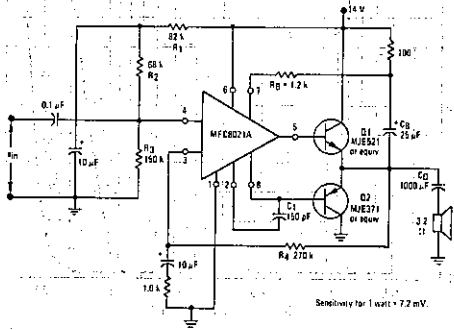
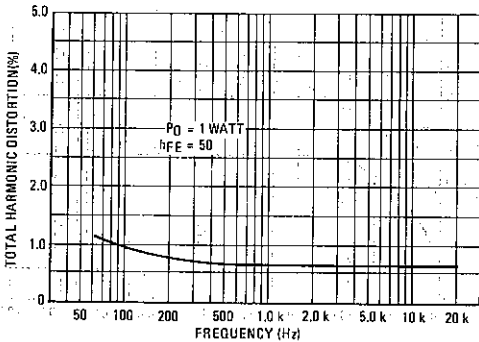

FIGURE 5 - TOTAL HARMONIC DISTORTION versus FREQUENCY



APPLICATIONS INFORMATION for MFC8021A (AUTO RADIO AUDIO)

The MFC8021A combines all the voltage gain required for an automotive radio audio amplifier into one package reducing the circuit-board area requirement. The circuit shown in Figure 3 has an input sensitivity of approximately 7.2 millivolts for a one-watt output. Sensitivity can be adjusted by changing the value of R_4 . The circuit performance is a function of the output device h_{FE} , as shown in Figure 4; Figure 4 can be used to determine the minimum h_{FE} of the output transistors. The bandwidth of the amplifier is determined by the capacitor, C_1 . If C_1 is increased to 390 pF the high frequency 3.0 dB point is typically 20 kHz.

An illustration of the copper side of the printed-circuit board layout is shown in Figure 7. The output transistors are mounted on the heatsink which for auto radio audio applications should have a maximum thermal resistance of 18°C/W for each device or 9.0°C/W when both output transistors are mounted on the same heatsink.

FIGURE 4 - TOTAL HARMONIC DISTORTION versus OUTPUT POWER

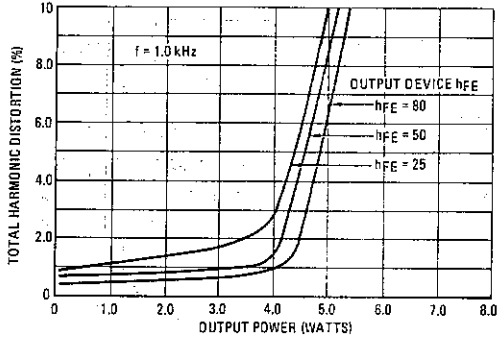

FIGURE 6 - FREQUENCY RESPONSE

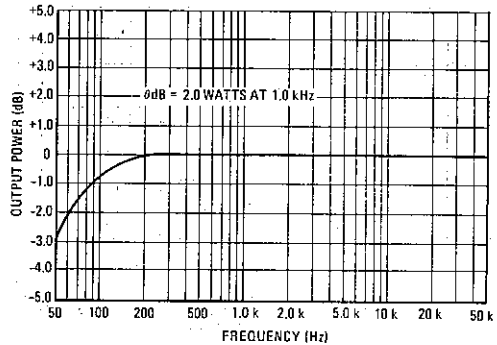
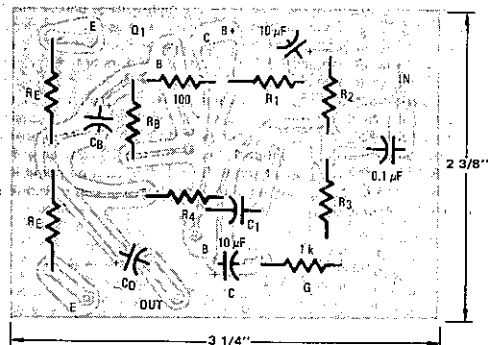

FIGURE 7 - PRINTED CIRCUIT BOARD (for AUTOMOTIVE RADIO AUDIO 10 and 20 WATT AMPLIFIERS (COPPER SIDE))



TYPICAL 10-and-20 WATT AMPLIFIER APPLICATION AND CHARACTERISTICS

(T_A = +25°C unless otherwise noted.)

FIGURE 8 — APPLICATION CIRCUIT for MFC8020A and MFC8022A

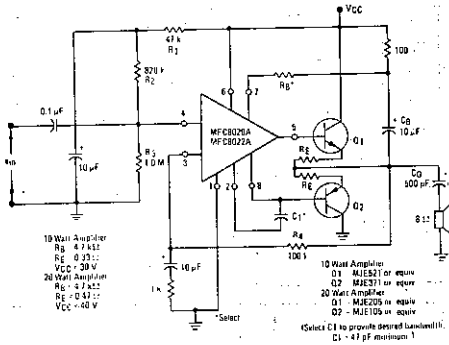

FIGURE 9 — TOTAL HARMONIC DISTORTION versus OUTPUT POWER

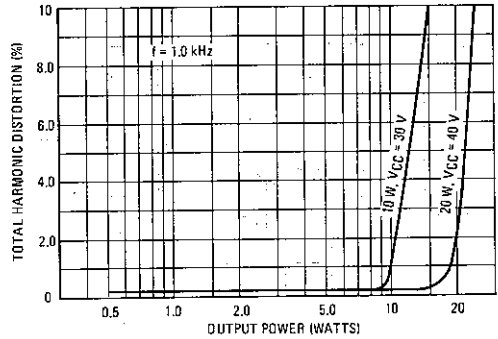

FIGURE 10 — TOTAL HARMONIC DISTORTION versus FREQUENCY

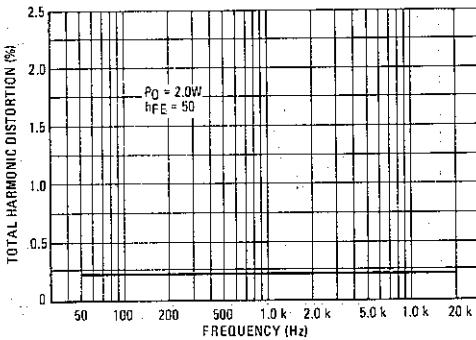
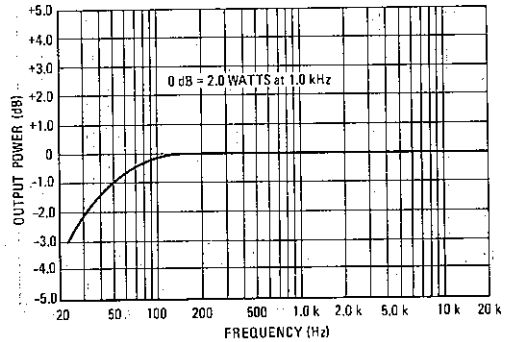

FIGURE 11 — FREQUENCY RESPONSE



APPLICATIONS INFORMATION for MFC8020A and MFC8022A (10-Watt and 20-Watt Amplifiers)

The MFC8020A and MFC8022A are high-voltage parts capable of driving 10-to-20 watt audio amplifiers. The gain of the circuit shown in Figure 8 changes when the value of R₄ is varied and the bandwidth is determined by C₁. Emitter resistors are required at the higher voltages used for 10-to-20 watt audio amplifiers to provide thermal stability. The value of R_E is a function of the heatsink thermal resistance and supply voltage. The heatsink requirements for operation at +65°C (with both devices mounted on the same heatsink) is about 14°C/W for the 10-watt amplifier and 8.0°C/W for the 20-watt amplifier. If the maximum ambient operating temperature is reduced then the heatsink can be reduced in size as calculated by

$$\theta_{SA} = \frac{T_J - (\theta_{JS}) P_D - T_A}{P_D}$$

where

θ_{SA} = Heatsink thermal resistance

T_J = Maximum junction operating temperature

θ_{JS} = Junction to heatsink thermal resistance (includes all surface interface components for thermal resistance such as the insulating washer)

P_D = Maximum power dissipation of transistors (This occurs at about 60% of maximum output power) 6.0 W for 10 W, 7.2 W for 12 W

T_A = Maximum ambient temperature

The printed circuit board layout is shown in Figure 7.