



LA2902V

Four-Channel High-Output Line Amplifier for Car Audio Systems

Overview

The LA2902V is a high output level 4-channel line amplifier designed for car audio systems. This line amplifier provides an output signal with a significantly higher amplitude than the output signal provided by earlier preamplifiers. This higher amplitude significantly improves the signal-to-noise ratio in the connection from the main unit to the external power amplifier, and results in improved power amplifier performance.

The LA2902V also significantly reduces the required mounting area by cutting in half the number of external capacitors required for boosting the signal-system supply voltage and is available in SSOP miniature package.

Functions and Features

- High output level (5.3 Vrms)
- Low output noise voltage (17 μ V)
- Low total harmonic distortion (0.004%)
- High ripple rejection ratio (65 dB)
- Fewer external parts required
- Excellent audio fidelity

Specifications

Maximum Ratings at Ta = 25°C

Parameter	Symbol	Conditions	Ratings	Unit
Maximum supply voltage	V _{CC} max	With no input signal	13	V
Allowable power dissipation	P _d max	T _a ≤ 85°C, Mounted on a printed circuit board (114.3 × 76.1 × 1.6 mm ³ , glass epoxy)	400	mW
Operating temperature	T _{opr}		-40 to +85	°C
Storage temperature	T _{stg}		-40 to +150	°C

Package Dimensions

unit: mm

3175B-SSOP24 (275 mil)

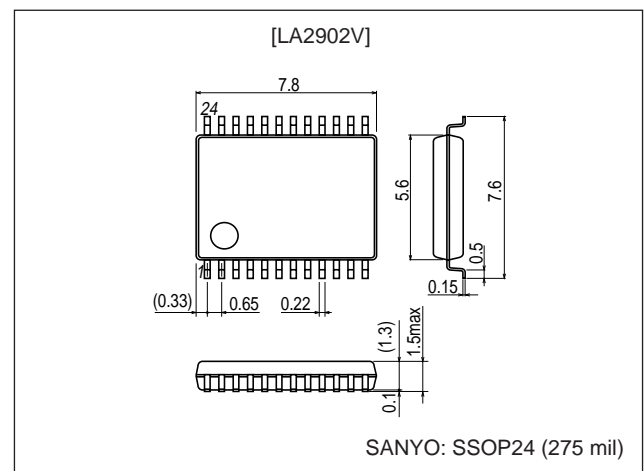

■ Any and all SANYO products described or contained herein do not have specifications that can handle applications that require extremely high levels of reliability, such as life-support systems, aircraft's control systems, or other applications whose failure can be reasonably expected to result in serious physical and/or material damage. Consult with your SANYO representative nearest you before using any SANYO products described or contained herein in such applications.

■ SANYO assumes no responsibility for equipment failures that result from using products at values that exceed, even momentarily, rated values (such as maximum ratings, operating condition ranges, or other parameters) listed in products specifications of any and all SANYO products described or contained herein.

SANYO Electric Co.,Ltd. Semiconductor Company

TOKYO OFFICE Tokyo Bldg., 1-10, 1 Chome, Ueno, Taito-ku, TOKYO, 110-8534 JAPAN

LA2902V

Recommended Operating Conditions at $T_a = 25^\circ\text{C}$

Parameter	Symbol	Conditions	Ratings	Unit
Recommended operating voltage	V_{CC}		9	V
Allowable operating supply voltage range	V_{CCOP}		6 to 12	V
Recommended load resistance	R_{LOP}		10	$k\Omega$

Electrical Characteristics at $T_a = 25^\circ\text{C}$, $V_{CC} = 9\text{ V}$, $R_L = 10\text{ k}\Omega$, $f = 1\text{ kHz}$, $R_g = 600\Omega$

Parameter	Symbol	Conditions	Ratings			Unit
			min	typ	max	
Quiescent current	I_{CCO}	$R_g = 0$	10	16	22	mA
Voltage gain	V_G	$V_O = 0\text{ dBm}$	11.5	12	12.5	dB
Output voltage	V_O	THD = 0.1%	5.0	5.3		V _{rms}
Total harmonic distortion	THD	$V_O = 3\text{ V}_{rms}$, LPF = 80 kHz		0.004	0.01	%
Output noise voltage	V_{NO}	$R_g = 0$, BPF = 20 Hz to 20 kHz		17	24	μV_{rms}
Ripple rejection ratio	SVRR	$R_g = 0$, $f_r = 100\text{ Hz}$, $V_r = 100\text{ mV}_{rms}$, BPF = 20 Hz to 20 kHz	55	65		dB
Channel separation	CH_{sep}	$R_g = 10\text{ k}\Omega$, $V_O = 1\text{ V}_{rms}$	60	70		dB
Input resistance	R_i		21	30	39	$k\Omega$

Pin Assignment

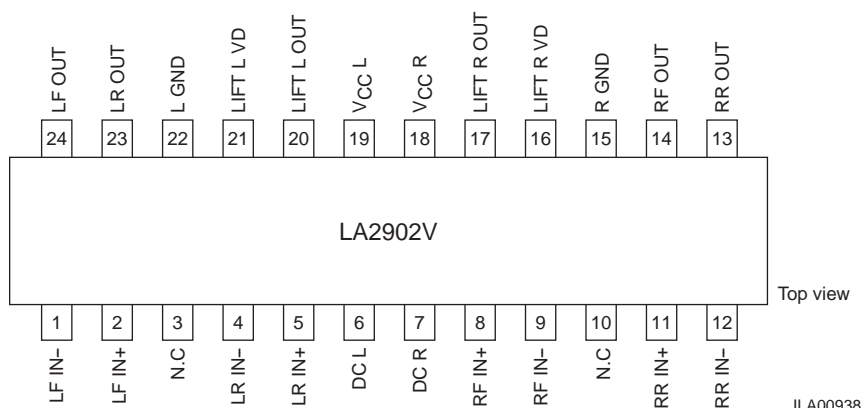

Sample Application Circuit and Block Diagram

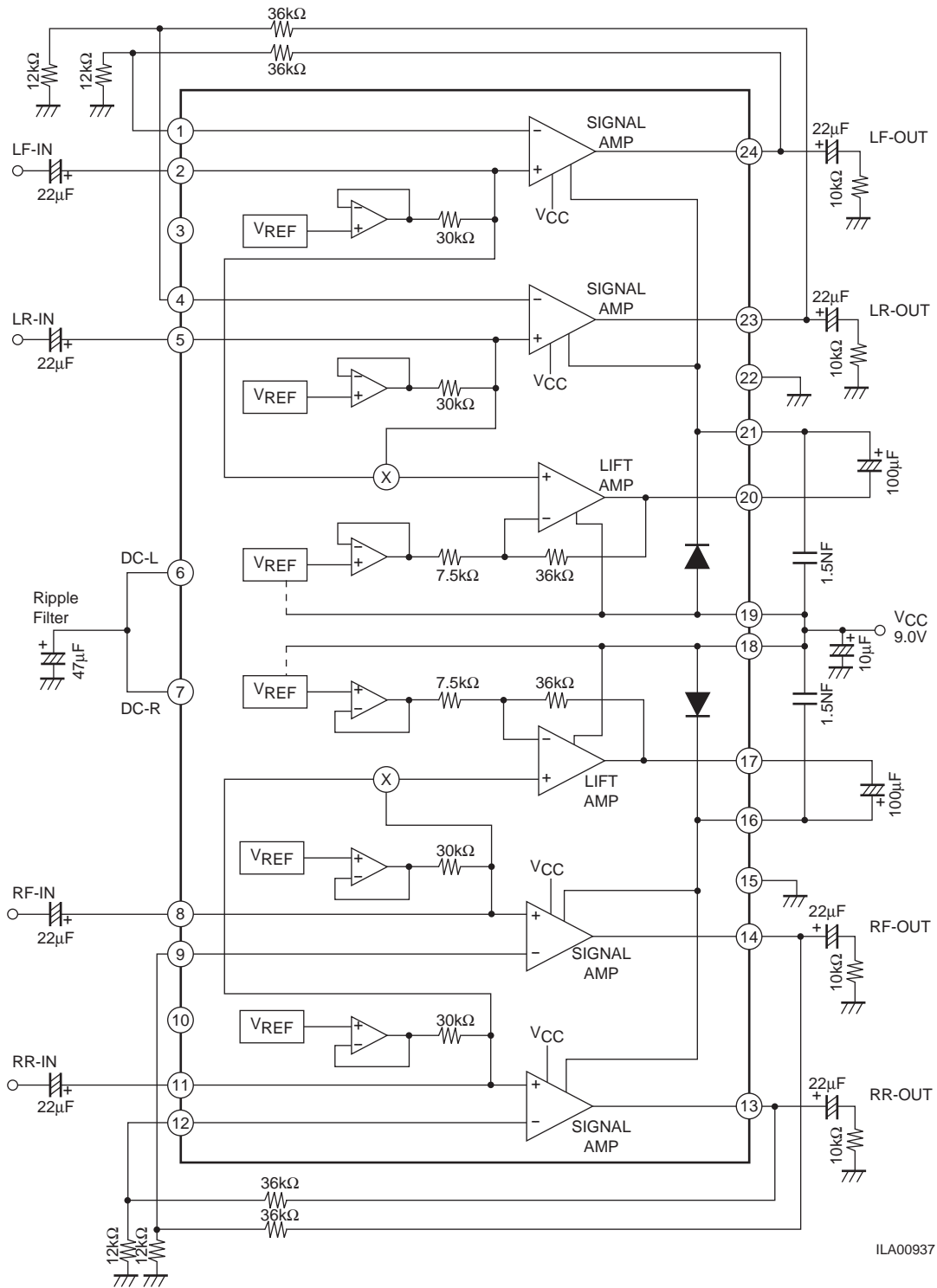

ILA00937

Note: We recommend using resistors with tolerances of 1% or better for the 12 kΩ and 36 kΩ feedback resistors.

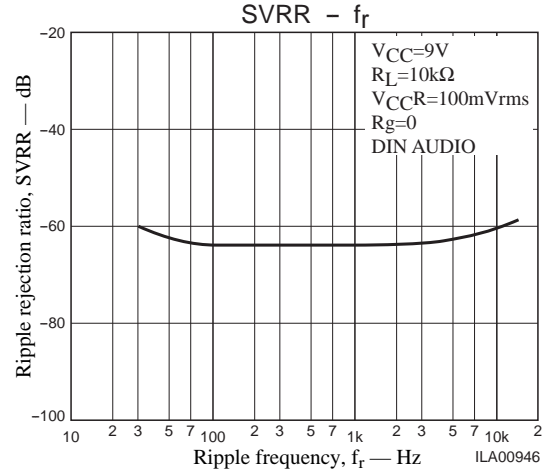
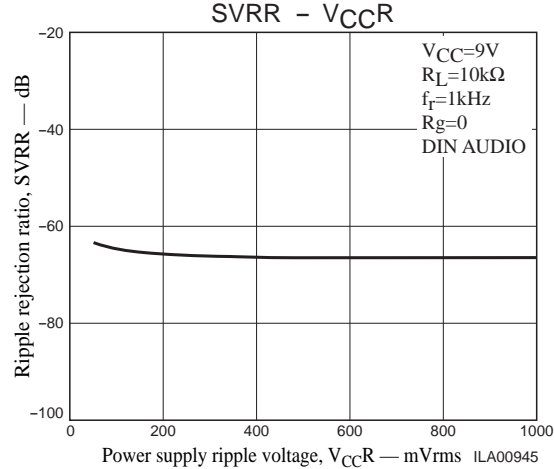
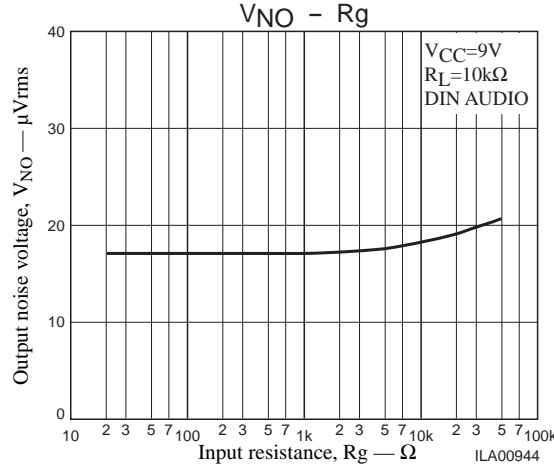
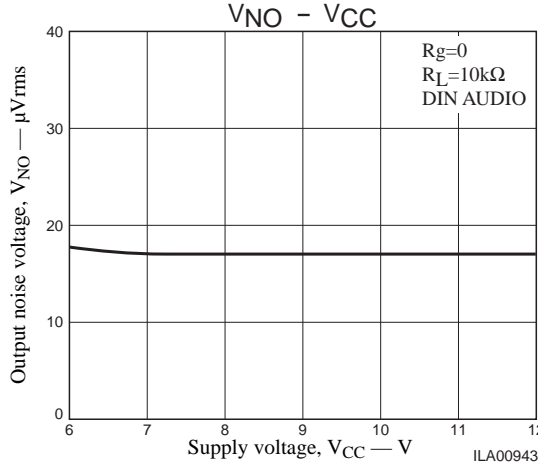
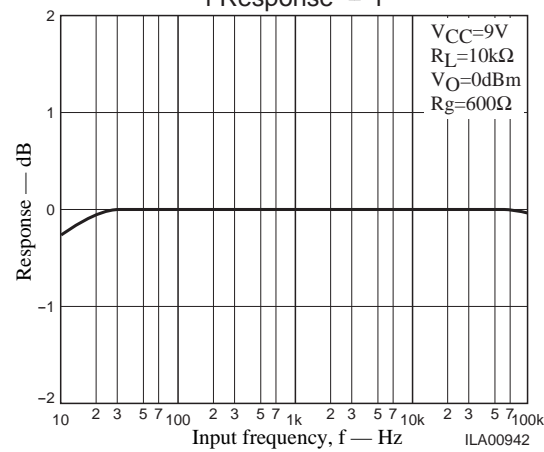
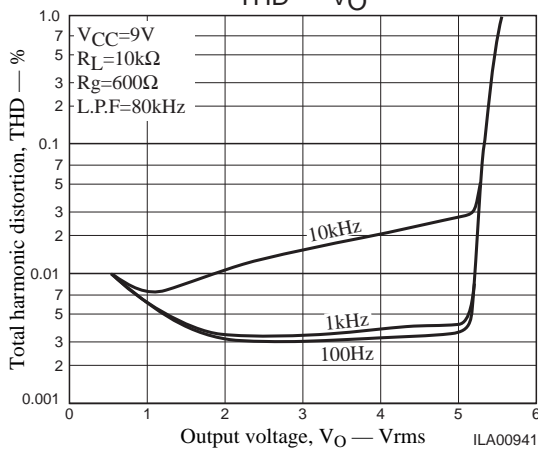
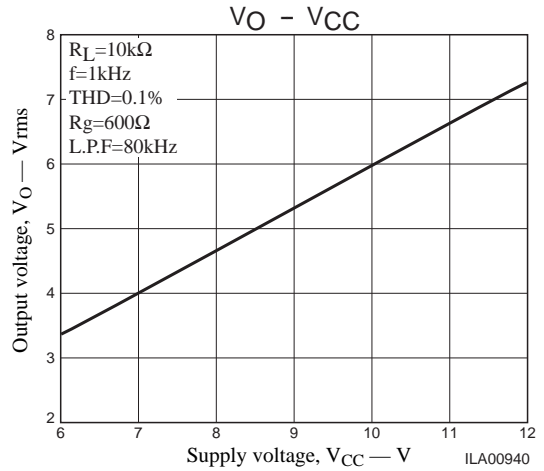
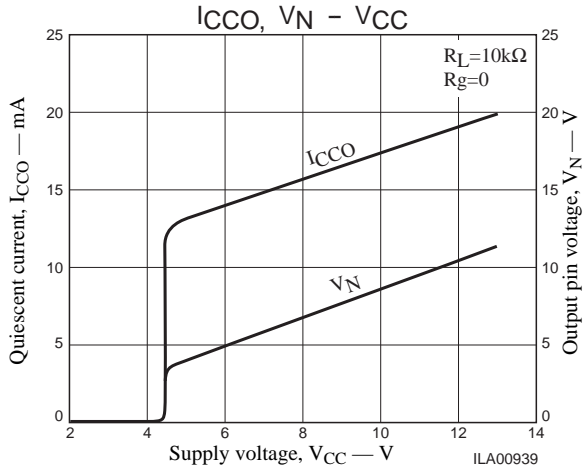

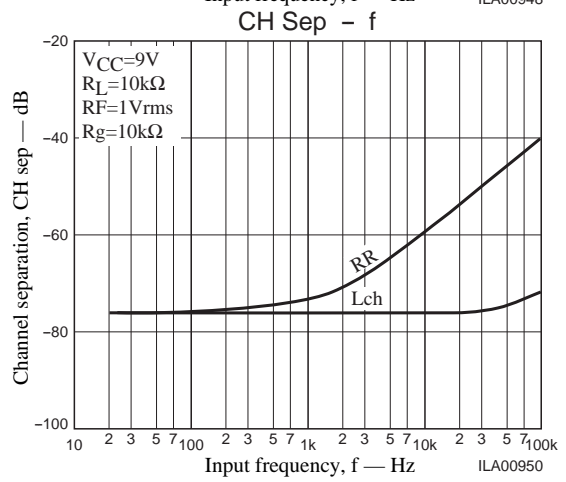
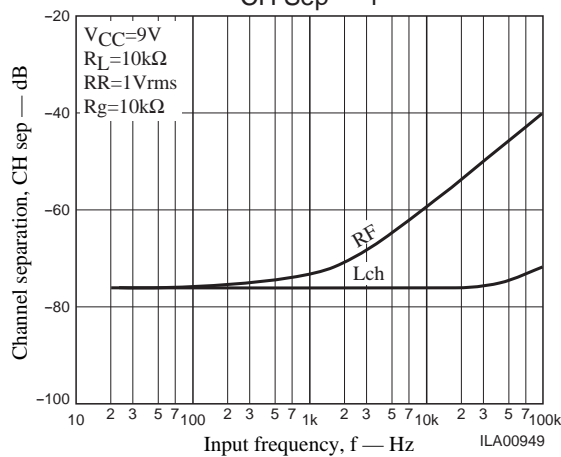
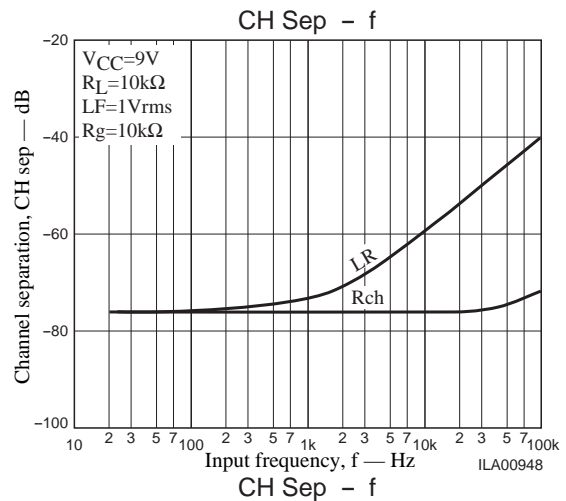
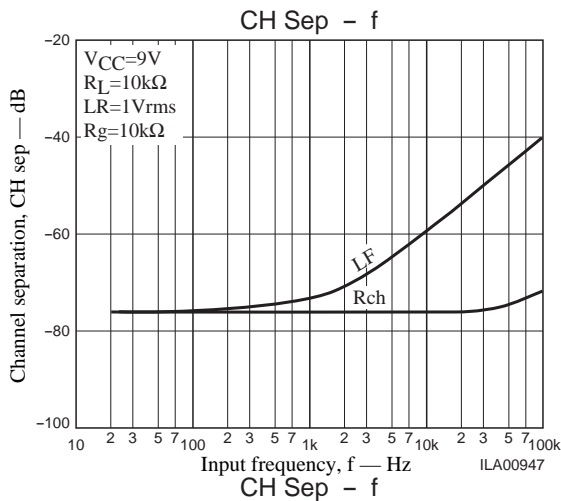

- Specifications of any and all SANYO products described or contained herein stipulate the performance, characteristics, and functions of the described products in the independent state, and are not guarantees of the performance, characteristics, and functions of the described products as mounted in the customer's products or equipment. To verify symptoms and states that cannot be evaluated in an independent device, the customer should always evaluate and test devices mounted in the customer's products or equipment.
- SANYO Electric Co., Ltd. strives to supply high-quality high-reliability products. However, any and all semiconductor products fail with some probability. It is possible that these probabilistic failures could give rise to accidents or events that could endanger human lives, that could give rise to smoke or fire, or that could cause damage to other property. When designing equipment, adopt safety measures so that these kinds of accidents or events cannot occur. Such measures include but are not limited to protective circuits and error prevention circuits for safe design, redundant design, and structural design.
- In the event that any or all SANYO products (including technical data, services) described or contained herein are controlled under any of applicable local export control laws and regulations, such products must not be exported without obtaining the export license from the authorities concerned in accordance with the above law.
- No part of this publication may be reproduced or transmitted in any form or by any means, electronic or mechanical, including photocopying and recording, or any information storage or retrieval system, or otherwise, without the prior written permission of SANYO Electric Co., Ltd.
- Any and all information described or contained herein are subject to change without notice due to product/technology improvement, etc. When designing equipment, refer to the "Delivery Specification" for the SANYO product that you intend to use.
- Information (including circuit diagrams and circuit parameters) herein is for example only; it is not guaranteed for volume production. SANYO believes information herein is accurate and reliable, but no guarantees are made or implied regarding its use or any infringements of intellectual property rights or other rights of third parties.

This catalog provides information as of October, 2001. Specifications and information herein are subject to change without notice.